

# SKIPPER

## 2 Axis Electromagnetic Log

### EML224

# Operation and Installation Manual



SKIPPER Electronics AS  
Enebakkveien 150  
P. O. Box 151, Manglerud  
0612 Oslo, Norway  
www.skipper.no

Telephone: +47 23 30 22 70  
Telefax: +47 23 30 22 71  
E-mail: support@skipper.no  
Co. reg. no: NO-965378847-MVA

Document number: **DM-E001-SB.**  
Edition: 2012-05-15  
Revision sw.:1.27.23.

## Information

Please visit our web site [www.skipper.no](http://www.skipper.no) for additional information. Here you will find product bulletins, software updates, instruction manuals, installation procedures etc.

## Important

During installation, consideration must be taken, such that the sensor and cable can be removed for service purposes. Filling pipes or tubes is **not** recommended unless strictly necessary.

Weitergabe sowie vervielfältigung dieser unterlage, verwertung und mitteilung ihres inhaltes nicht gestattet, soweit nicht ausdrücklich zugestanden. zuwiderhandlungen verpflichten zu schadenersatz.

Copying of this document, and giving it to others and the use or communication of contents thereof, are forbidden without express authority. Offenders are liable to the payment of damages.

Toute communication ou reproduction de ce document, toute exploitation ou communication de ou son contenu sont interdites, sauf autorisation expresse. Tout manquement à cette règle est illicite et expose son auteur au versement de dommages et intérêts.

Sin nuestra expresa autorización, queda terminantemente prohibida la reproducción total o parcial de este documento, así como su uso indebido y/o su exhibición o comunicación a terceros. De los infractores se exigirá el correspondiente resarcimiento de daños y perjuicios.

# Contents

<b>1. INTRODUCTION.....</b>	<b>6</b>
System Summary.....	6
Sensor.....	6
Operator Unit.....	6
Data Entry.....	6
Fig. 1.1 System Overview.....	7
Interfacing.....	8
Outputs.....	8
Inputs.....	8
Alarms.....	8
Display Unit panel layout.....	8
Fig. 1.2. Display unit panel layout.....	8
<b>2. OPERATION.....</b>	<b>9</b>
Parameter entry.....	9
Fig. 2.1 Setting and Parameter Entry Flowchart.....	9
Operation Screens.....	10
Fig. 2.2. Schematic overview of screens and soft key menus.....	10
Fig. 2.3. Screen A.....	11
Fig. 2.4. Screen B.....	12
Fig. 2.5 A. Screen Com, Menu 1.....	13
Fig. 2.5 B. Screen Com, Menu 1 Error/Warning messages.....	14
Fig. 2.6. Screen Com, Menu 2.....	15
Fig. 2.7. Screen Com, Menu 2, sensor.....	16
Fig. 2.8. Screen Status, Menu 1.....	17
Fig. 2.9. Screen Status, Menu 2.....	18
Fig. 2.10 Screen Status, Menu 3.....	19
Fig. 2.11. Screen Status, Menu 4.....	20
Fig. 2.12. Screen Status, Menu 5.....	21
Fig. 2.13. Screen Status, Menu 6.....	22
Fig. 2.14. Screen Calibration, Menu 1.....	23
Fig. 2.15. Screen Calibration, Menu 2.....	24
Fig. 2.16. Screen Calibration, Menu 3.....	25
Principal Functions.....	26
Principles of Electromagnetic Log.....	26
Power ON/OFF.....	26
Alarm acknowledgement.....	26
Fixed Key Functions.....	26
Screen Select.....	26
Backlight adjustment.....	26
Day/Night.....	26
Key Functions.....	26
Menu.....	26
Trip Reset.....	27
Alarm Settings.....	27
Alarm ID.....	27
Clock and Calendar Settings.....	27
Simulator.....	27
Status Screen.....	27
Nonvolatile Parameter Memory.....	27
Options.....	27
Repeaters/speed and distance.....	27
<b>3. USER MAINTENANCE.....</b>	<b>28</b>

Sensor Maintenance.....	28
Operator Unit Maintenance .....	28
<b>4. INSTALLATION .....</b>	<b>29</b>
Standard System Supply .....	29
Hull Fitting .....	29
Sensor Location .....	29
Part Positioning and Welding .....	29
The Electronic Unit .....	30
Sensor/Electronic Unit interconnection.....	30
Transducer/Electronic Unit PCB .....	31
Fig. 4.2. Sensor /Electronic Unit, Wiring diagram.....	31
Operator Unit Installation.....	32
115/230 V on Combo Terminal board inside Display Unit .....	32
Fig. 4.3. Voltage selection connectors and fuses, Terminal Board, EML224 Operator Unit. ....	33
Fig. 4.4. Back-up Battery Jumper, I/O Board.....	34
Back-up Battery Jumper JP200 .....	34
Fig. 4.5. Function LEDs, Terminal Board.....	35
Power indication and function LEDs .....	35
Interfacing.....	36
Fig. 4.6. Input/Output Circuitry.....	36
Interfacing .....	37
Alarm Relay .....	37
Log Pulse Outputs .....	37
Analogue Interfaces.....	37
Fig. 4.7. Alarm interconnection.....	38
Fig. 4.8. Misc IO examples .....	39
External Interface Ports .....	40
NMEA interface.....	40
Options .....	40
Repeaters .....	40
<b>5. START-UP AND SYSTEM ADAPTION.....</b>	<b>41</b>
Analogue Outputs and Log Pulse Outputs Range Selection .....	41
Language and Units of Measure.....	41
NMEA Setup .....	41
Fig. 5.1 9 Pin D-Type NMEA connector XJ402 in cabinet front .....	42
EML224 transmitted (originated) NMEA 0183 messages .....	42
<b>6. CALIBRATION PROCEDURE .....</b>	<b>43</b>
Heading Error .....	43
Fig. 6.1 Sea valve alignment .....	43
Speed variations due to drag or mounting tilt. ....	44
Calibration routine:.....	44
Activation of the hidden menus .....	44
Step 1. Heading error correction: .....	45
Step 2a. Manual speed calibration/adjustment: .....	45
Step 2b. Semi Automatic calibration: .....	46
<b>7. SPECIFICATIONS.....</b>	<b>48</b>
Dimensions .....	48
Functional Properties.....	48
Performance.....	48
Environmental according to IEC60945 .....	49



**8. TROUBLE SHOOTING ..... 50**

- Basic System Integrity..... 50
- Installation problems ..... 51
- Interface problems..... 51
- Basic functionality..... 51
- Typical Status Screen Contents ..... 52
- Fig. 8.1 Typical contents of status screen..... 52

**9. CPU BOARD SETUP PROCEDURE..... 53**

- CPU PCA 6742VE ..... 53
- Master Reset Procedure..... 54
- Upgrading Software..... 54

**10. SERVICE..... 55**

**11. APPENDIX ..... 56**

- Miscellaneous Installation Drawings. .... 56
  - Fig. 11.1. EML224 System overview..... 57
  - Fig. 11.2. Terminal board connections ..... 58
  - Fig. 11.3 Outline dimensions Display Unit..... 59
  - Fig. 11.4 Outline dimensions Electronic Unit ..... 60
  - Fig. 11.5 Cable gland connection ..... 61

**12. NOTES ..... 62**

**13. INDEX..... 63**

## 1. Introduction

---

### System Summary

The SKIPPER EML224 is a navigational electromagnetic log system containing sensor (transducer), display (operator) unit and an electronic (interconnection) unit. The sensor can be delivered in many different versions to fit functionality demands and different hull installations. The display unit can be a larger unit with a high resolution LCD or a smaller unit with dot-matrix LEDs. This manual only cover the version with the LCD unit.

The LCD can display a number of parameter in both numerical and graphic forms. The information from the electromagnetic sensor includes longitudinal and transversal speeds, drift angle and sea temperature. It is thus possible to get a very good picture of the vessels total movements.

The EML224 electromagnetic log will give direction of speed in both axis (ahead/astern and starboard/port). This is of great importance during manoeuvring or when running at low speeds. The speed range is the same astern and ahead. The user may select display text languages as well as various units of measure. All IMO requirements are met or exceeded. Comprehensive interfaces are available including NMEA 0183 input and output.

### Sensor

The sensor is an active electromagnetic unit that can be fitted into various tank or sea valve solutions. The sensor is virtually maintenance free, but occasional cleaning may be necessary depending on sea water conditions. Ordinary fouling will be limited, due to the electromagnetic field surrounding the sensor. The sensor has no moving parts and protrudes only a few millimetres outside the hull. The sensor is interfaced through an electronic unit which also contains the power supply. This unit is mounted near the hull fitting, and two twisted pairs of cable are led to the display/operator unit for digital signal transmission. The power consumption of the electronic unit is max. 35W. Voltage 115/230 V AC and/or 24 V DC.

### Operator Unit

The operator unit contains a colour TFT LCD display, a keyboard with fixed keys, soft keys and a rotating encoder. The function of each soft key depends on the active screen, and the buttons are labelled on the lower rim of the LCD. The display is backlit and backlight intensity may be adjusted by the user for both day and night vision. Various user-selectable information layouts, adapted to typical operational situations, may be displayed continuously on the LCD screen. The operator unit is normally flush mounted. Operator unit power supply options are 115/230 V AC or 24V DC. The power consumption is max. 70 Watts at 115/230 V AC and/or 50 Watts at 24V DC.

### Data Entry

Several screens may be selected to enter various settings and calibration parameters. Each screen has one or more soft key menus, selectable with the leftmost "MENU" soft key. Screen A and B are primary operation screens with appropriate operator controls. Screen COM, STATUS and CALIBRATION are setup and system supervision screens. The various screens will be described in detail later.

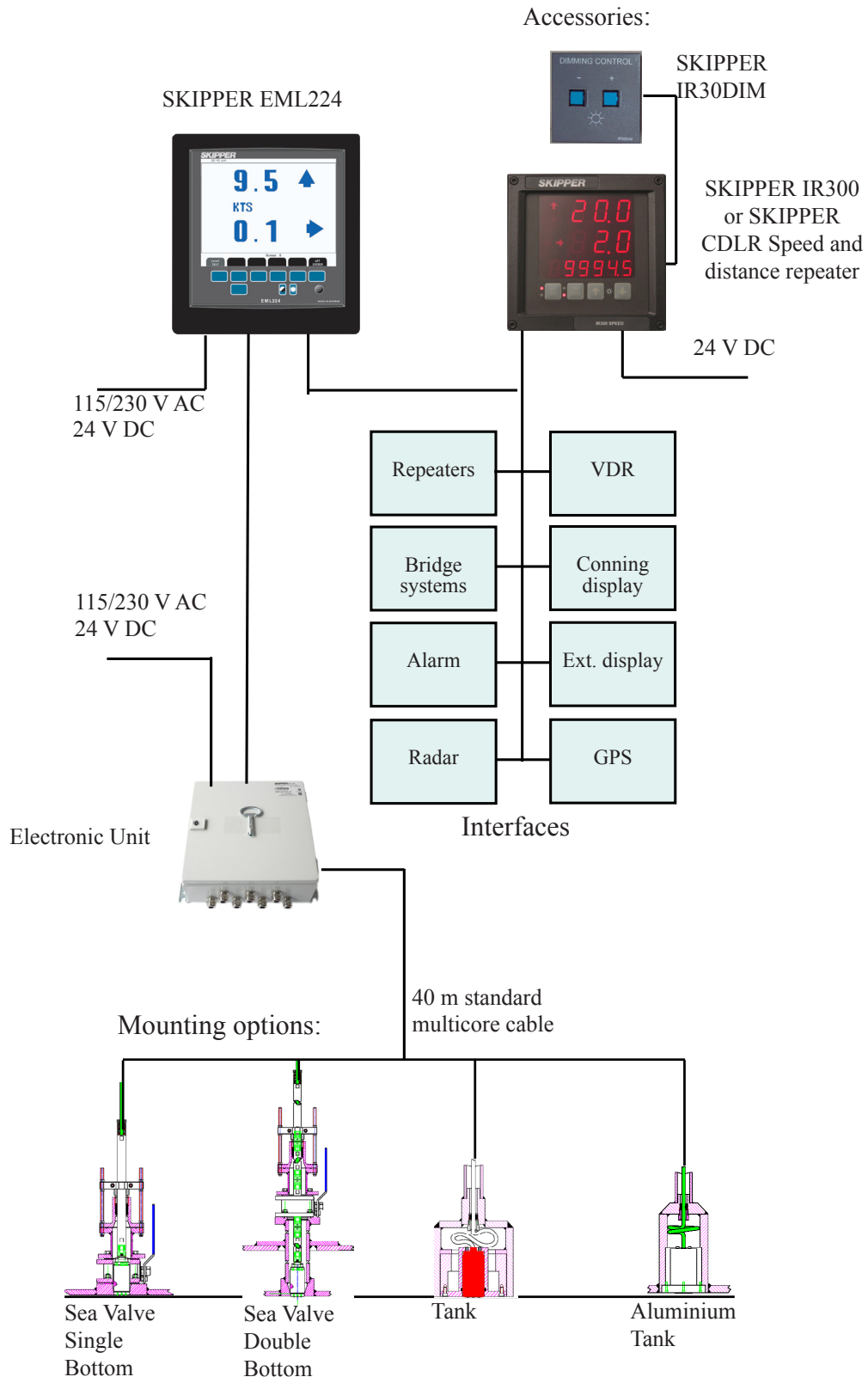

Fig. 1.1 System Overview

## Interfacing

The EML224 has various interface possibilities.

### Outputs

- 3 log pulse outputs 100/200/400/1000 pulses per nautical mile. See “[Log Pulse Outputs](#)” on page 37.
- 3 analogue outputs 0-10 V or 4-20 mA. See “[Analogue Interfaces](#)” on page 37.
- NMEA 0183 interface output. See “[NMEA interface](#)” on page 40 and “[NMEA Setup](#)” on page 41.
- External alarm relay output. See “[Alarm Relay](#)” on page 37.

### Inputs

- NMEA 0183 interface input. See “[NMEA Setup](#)” on page 41.
- Remote alarm reset. See “[Alarm Relay](#)” on page 37.

### Alarms

- High and low speed alarms may be selected from the menus. See “[Fig. 2.8. Screen Status, Menu 1](#)” on page 17.
- Input for remote alarm reset is available.

A potential free relay contact is provided in EML224 for interface to external alarm systems.

## Display Unit panel layout

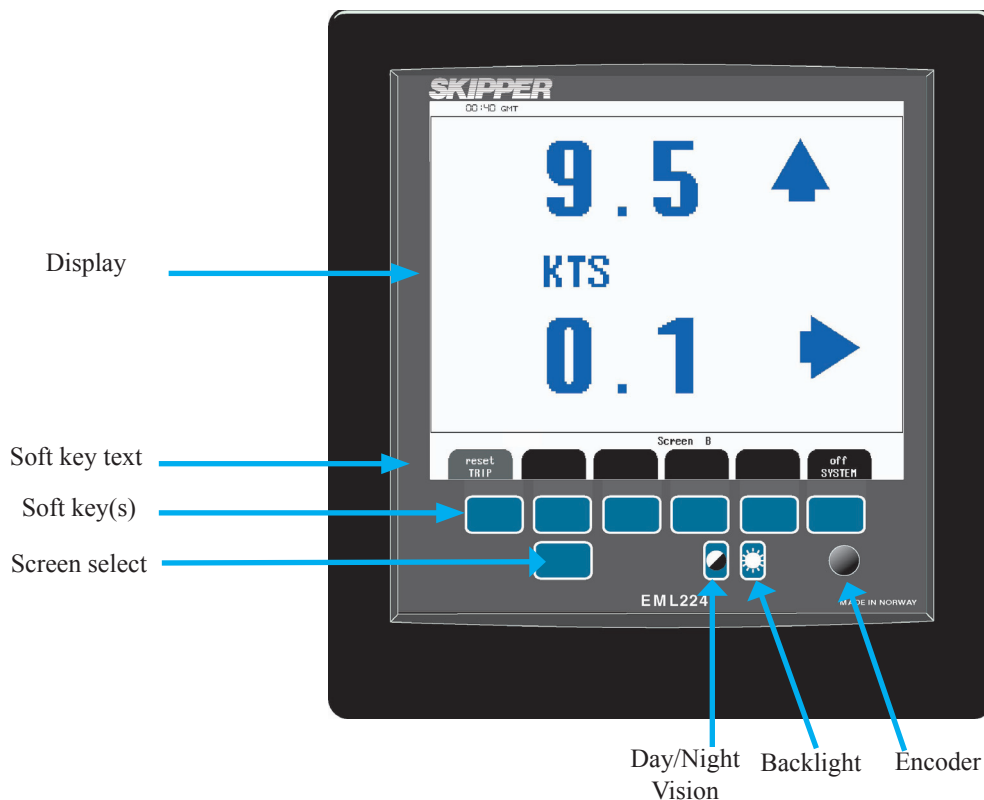

**Fig. 1.2. Display unit panel layout**

## 2. Operation

When the installation is complete, and power is connected to the operator unit, the system is switched on/off by a power switch inside the cabinet. The unit can also be switched off by pressing the SYSTEM Off softkey button on screen A and Screen B.

**Note: The unit is still energized. Do not perform any connections before switching off the mains on the terminal PCB inside the cabinet.**

### Parameter entry

The fixed function buttons and the soft key(s) on the various screens along with the rotating encoder, facilitates entry of parameters, setpoints and other data. The following flowchart illustrates the procedure for changing settings and entering data. The various screens are shown in detail in the operation section.

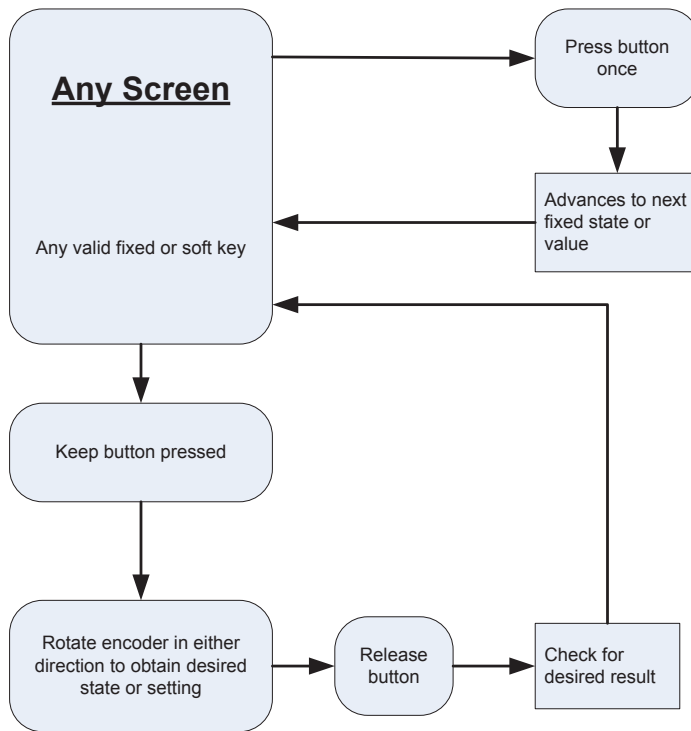

**Fig. 2.1 Setting and Parameter Entry Flowchart**

#### Example of parameter entry.

Suppose you want to enter a value of 15 knots for the high speed alarm. Press a high speed alarm soft key, e.g. in screen status, menu 1, and keep it pressed while you turn the encoder until you reach 15 knots, let go of the encoder and release the high speed alarm button.

## Operation Screens

Each of the operation screens contains a graphic picture and one or more menu sets configured on the 6 soft key buttons. The various screens are selected by keeping the SCREEN SELECT button pressed and rotating the encoder in either direction. Turning the encoder clockwise cycle the screens in the sequence 1 to 5, and counter clockwise rotation cycles the screens in the sequence 5 to 1. Screens A and B, covering the primary functions, may also be cycled by repeatedly pressing the SCREEN SELECT button. Screen COM, STATUS and CALIBRATION is mainly used for setup and function control, and may only be accessed by the rotating encoder.

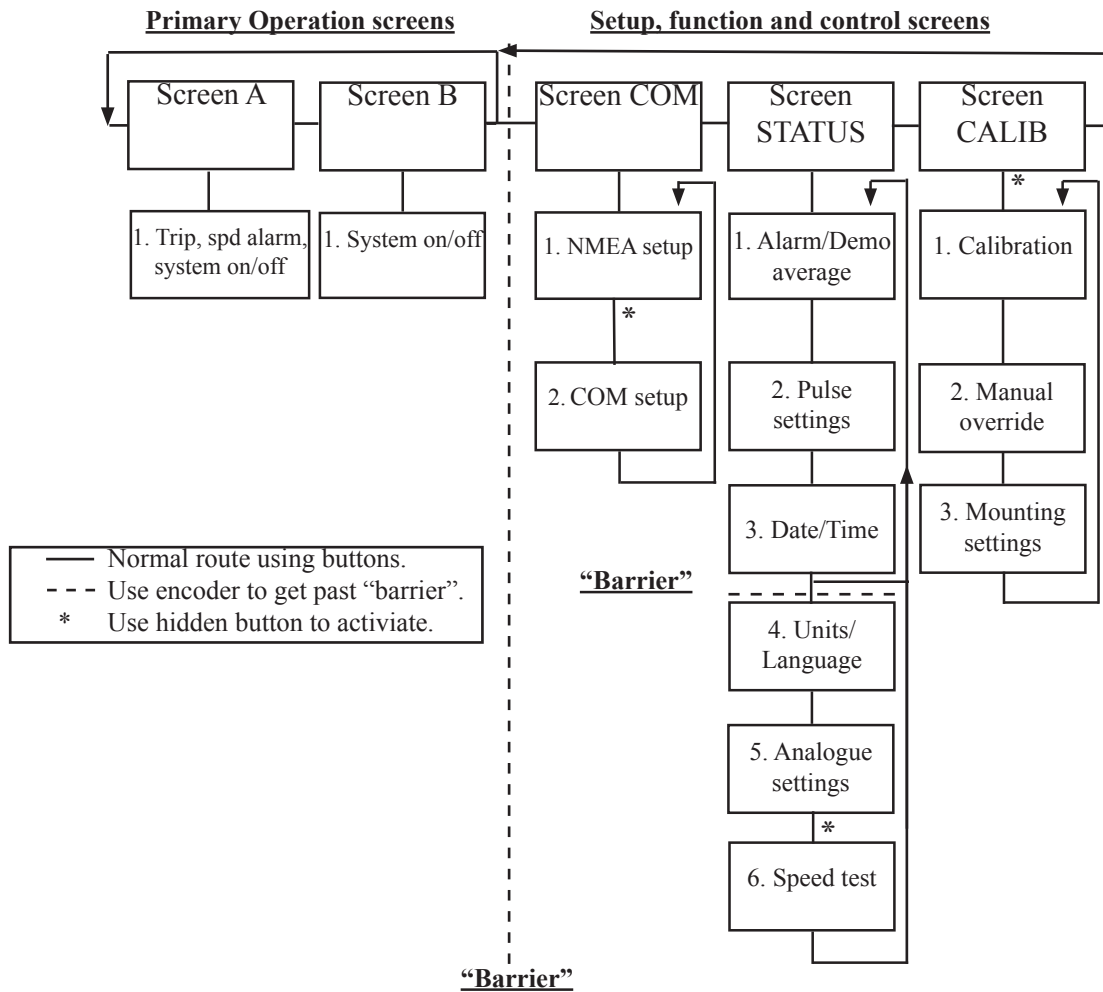

Fig. 2.2. Schematic overview of screens and soft key menus

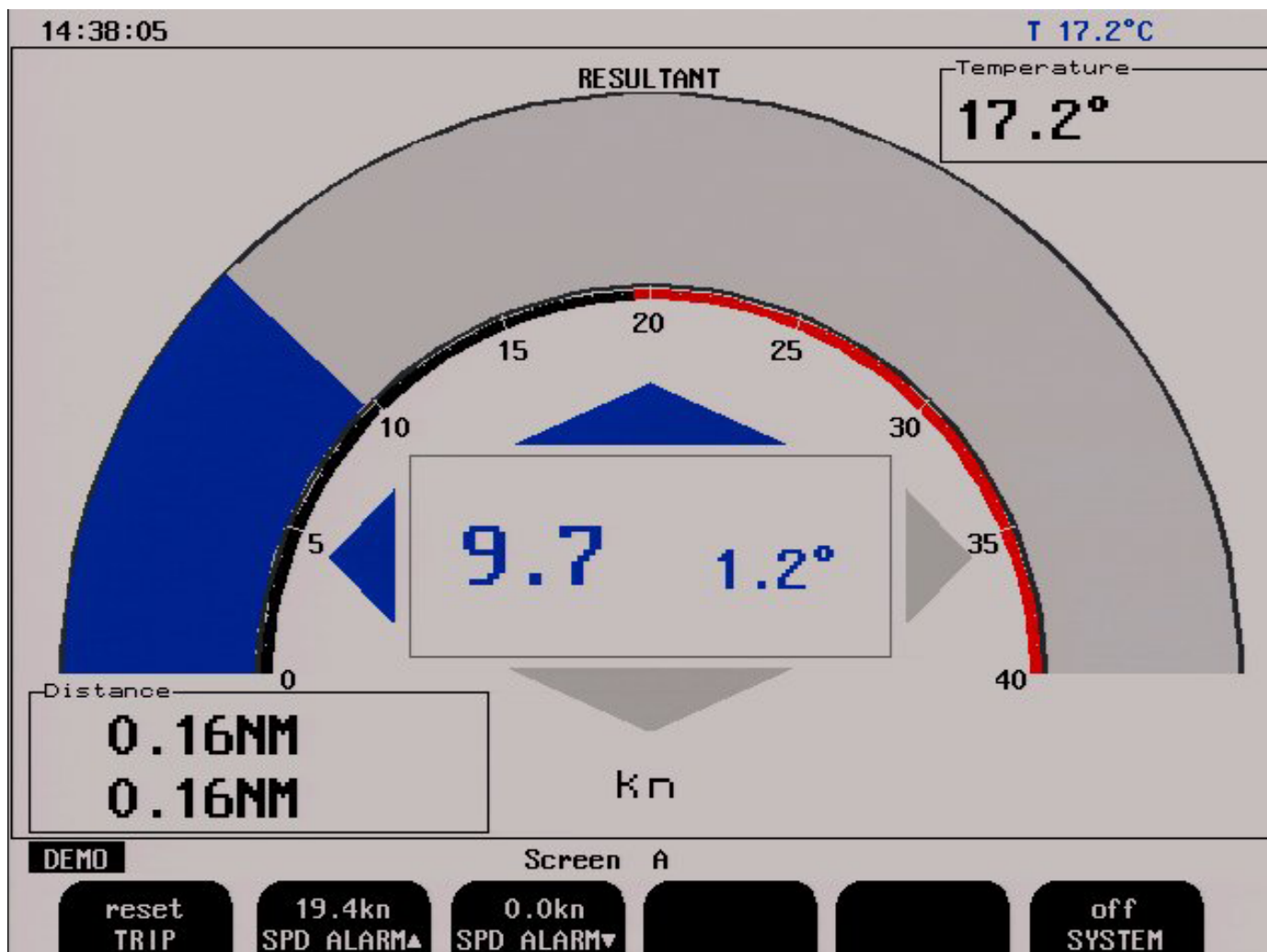

Fig. 2.3. Screen A

Soft key	Name	Range/value	Default value	Description	Activate with hidden button
1	TRIP	Reset		Trip distance counter reset.	
2	SPD ALARM▲	0.1 - 38.9 kn	19.4 kn	High speed alarm	
3	SPD ALARM▼	0.0 - 38.8 kn	0.0 kn	Low speed alarm	
4				Not used.	
5				Not used.	
6	SYSTEM	On/off	On	System off.	



Fig. 2.4. Screen B

Soft key	Name	Range/value	Default value	Description	Activate with hidden button
1				Not used.	
2				Not used.	
3				Not used.	
4				Not used.	
5				Not used.	
6	SYSTEM	On/off	On	System off.	



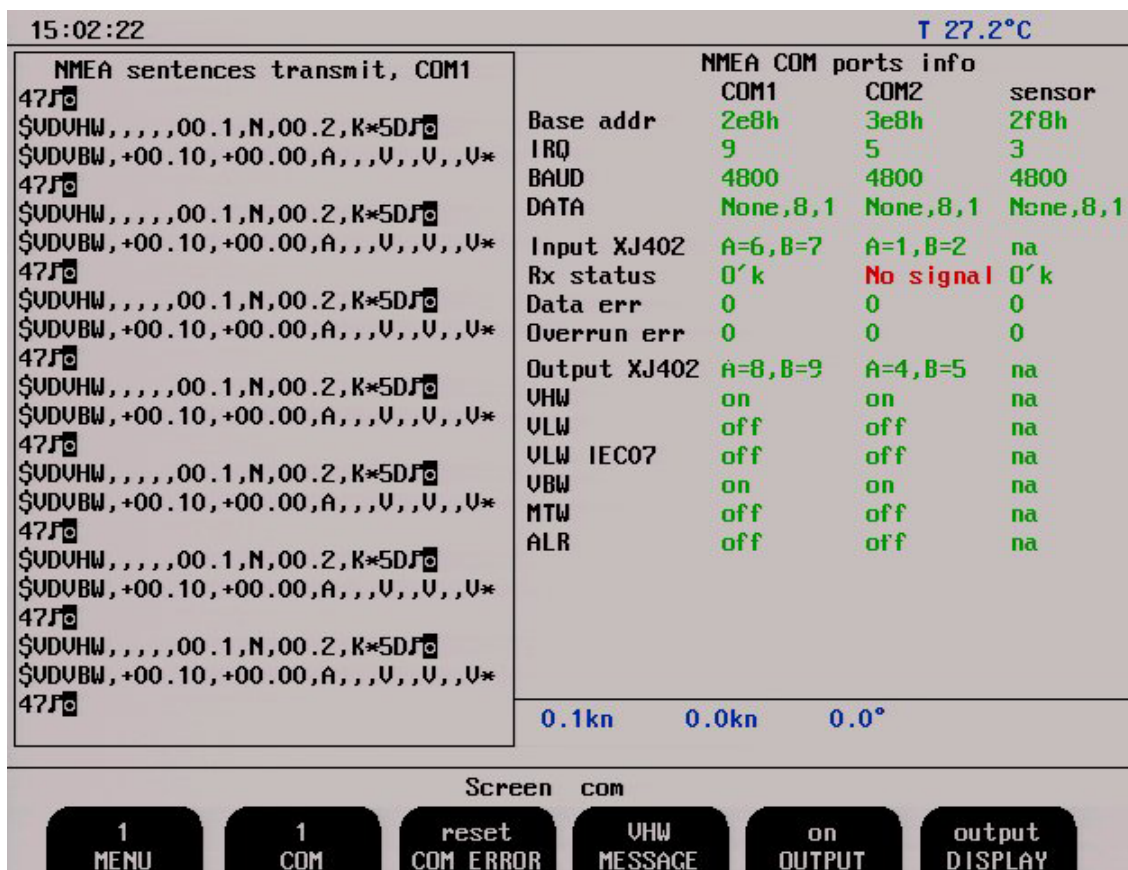

Fig. 2.5 A. Screen Com, Menu 1

Soft key	Name	Range/value	Default value	Description	Activate with hidden button
1	MENU	1 - 2	1	Chosen menu number 1.	
2	COM	1 - 2, sensor	1	Serial port number referred by other keys.	
3	COM ERROR	Reset		Reset field for COM errors. The program memorizes the latest occurred NMEA input error for further analysis. By using this softkey, it is possible to reset the error.	
4	MESSAGE	VHW, VLW, VLW IEC07, VBW, MTW, ALR		NMEA message selector. Each message may be controlled individually by soft key 5.	
5	OUTPUT	On/off	VHW: on VLW: off VLW IEC07: off VBW: on MTW: off ALR: off	Setting for the message in soft key 4 [On/Off] <b>Note:</b> To configure the serial output of the system, go through all the messages by pressing soft key 4 and set on/off value of the soft key 5 to disable/enable a message as required.	
6	DISPLAY	Input, off, output	Input	Selects the information (received from the external source or transmitted by the EML224) to be displayed in the "TEXT" window (left side). <ul style="list-style-type: none"> <li><b>Input:</b> Displays information received from external source.</li> <li><b>Output:</b> Displays information transmitted by EML224.</li> <li><b>Off:</b> None.</li> </ul>	

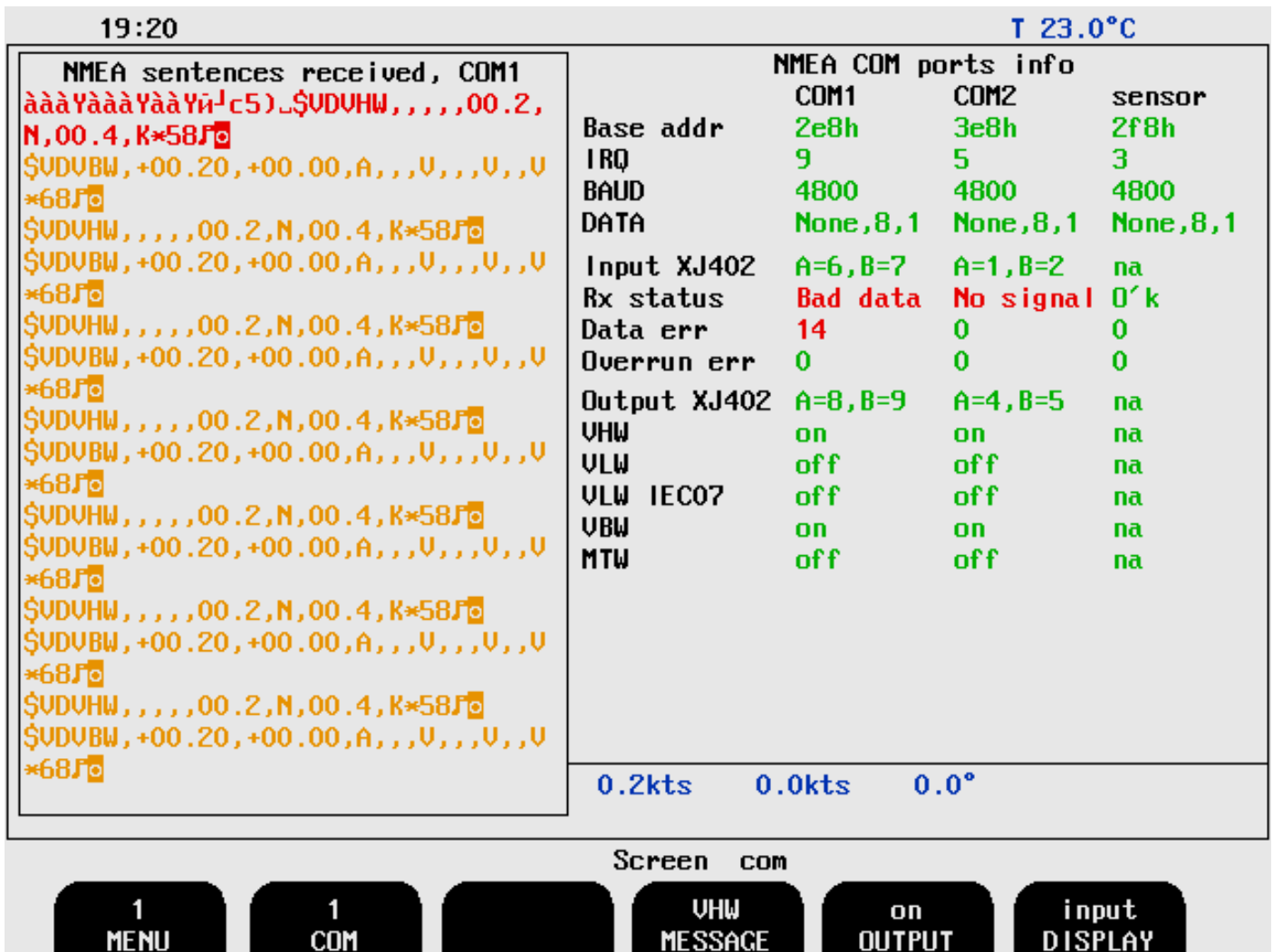

Fig. 2.5 B. Screen Com, Menu 1 Error/Warning messages

The right side of the screen shows the status of the available COM ports and the sensor. Showing in green which pins the ports are connected to on D-SUB type connector XJ402. Active NMEA protocols are also shown. The text window on the left side, when set to input DISPLAY, indicates what is being received and recognised by the unit.

- Accepted messages are shown in black type if the sentence is correct.
- Not of a recognised format, the text is orange.
- If something is wrong with the sentence, such as format or checksum, the text is in red.

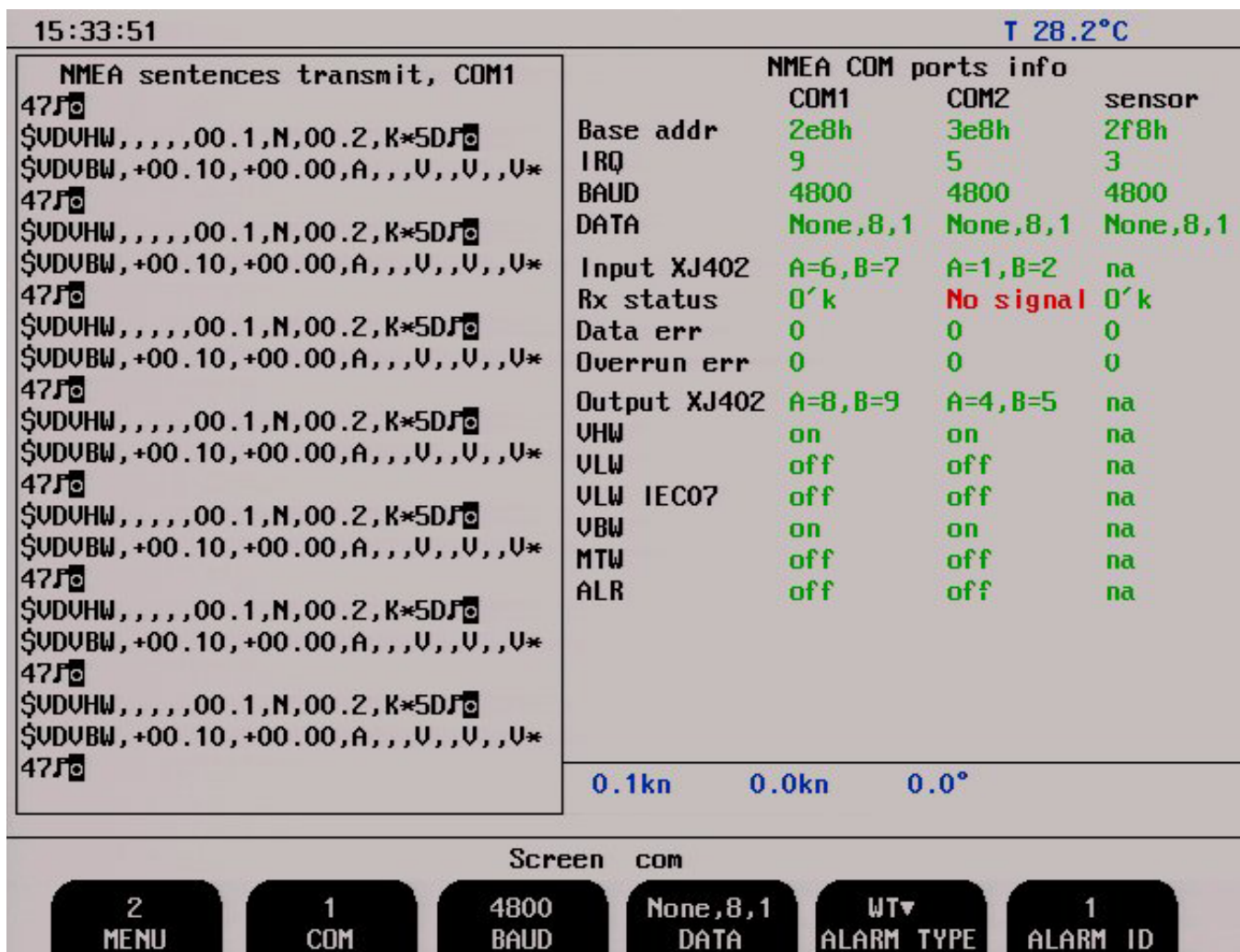

Fig. 2.6. Screen Com, Menu 2

Soft key	Name	Range/value	Default value	Description	Activate with hidden button
1	MENU	1 - 2	2	Chosen menu number 2.	
2	COM	1 - 2, Sensor	1	Serial port # referred by other keys.	
3	BAUD	1200, 2400, 4800, 9600, 19200, 38400, 57600, 115200.	4800	Baud rate for COM port #n.	
4	DATA	None-7-1, Even-7-1, Odd-7-1, None-8-1, Even-8-1, Odd-8-1, None-7-2, Even-7-2, Odd-7-2, None-8-2, Even-8-2, Odd-8-2,	None, 8, 1	Data format for COM port #n (Parity-data bits-stop bits).	
5	ALARM TYPE	WT▼, WT▲	WT▼	Each alarm type has its own alarm ID. This button selects which alarm .ID is to be viewed/changed.	
6	ALARM ID	1 - 999	1	Set the ID for the alarm selected.	

**Note:**

- BAUD and DATA appear dimmed when soft key 2 COM is in “Sensor” mode.

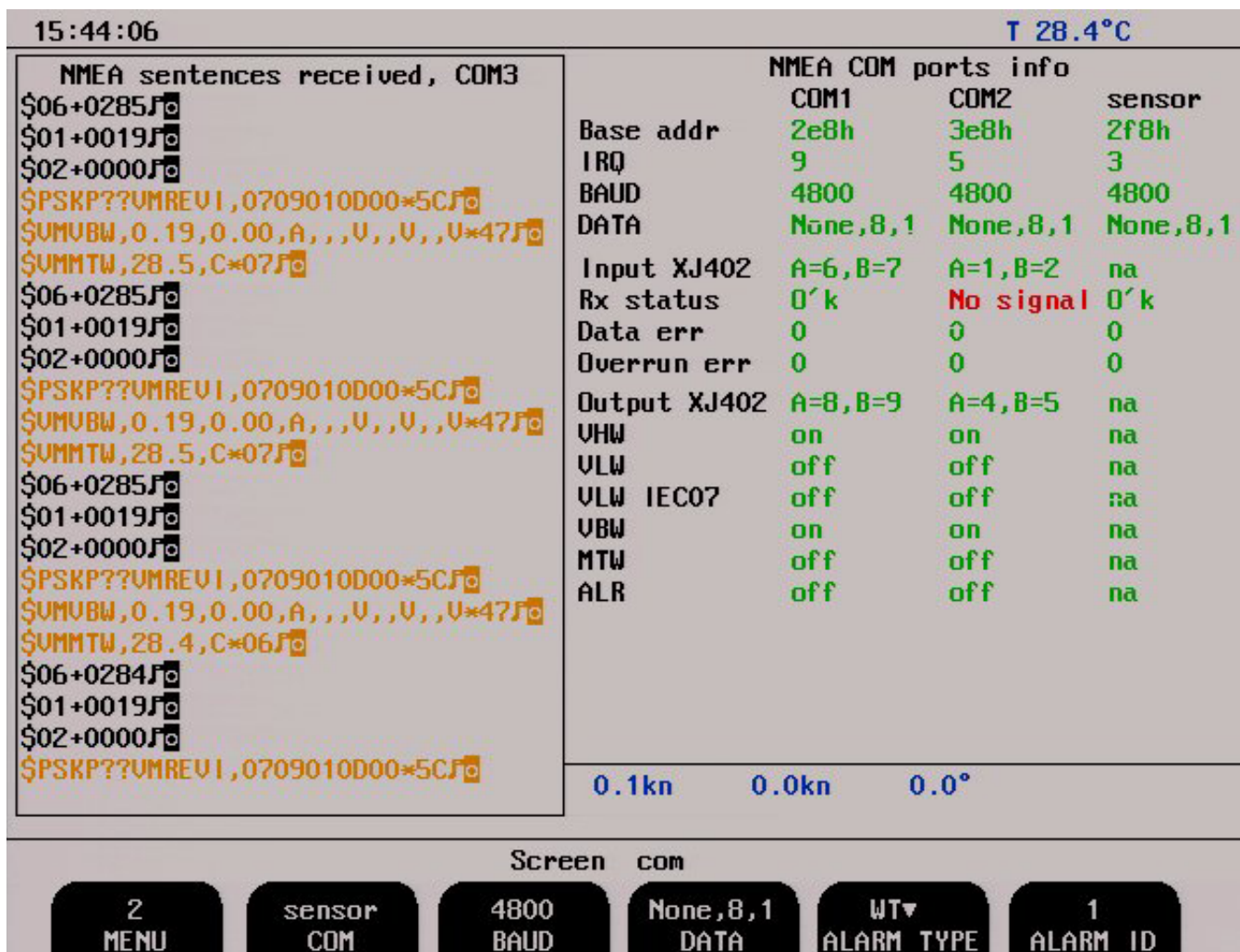

Fig. 2.7. Screen Com, Menu 2, sensor

Soft key	Name	Range/value	Default value	Description	Activate with hidden button
1	MENU	1 - 2	2	Chosen menu number 2.	
2	COM	1 - 2, Sensor	Sensor	Serial port # referred by other keys.	
3	BAUD	1200, 2400, 4800, 9600, 19200, 38400, 57600, 115200.	4800	Baud rate for COM port #n.	Yes, only when MENU 2 is selected.
4	DATA	None-7-1, Even-7-1, Odd-7-1, None-8-1, Even-8-1, Odd-8-1, None-7-2, Even-7-2, Odd-7-2, None-8-2, Even-8-2, Odd-8-2,	None, 8, 1	Data format for COM port #n (Parity-data bits-stop bits).	Yes, only when MENU 2 is selected.
5	ALARM TYPE	WT▼, WT▲	WT▼	Each alarm type has its own alarm ID. This button selects which alarm .ID is to be viewed/changed.	
6	ALARM ID	1 - 999	1	Set the ID for the alarm selected.	

**Note:** EML 224 Display Unit is receiving the following NMEA sentences on 4800 baud.

- \$06 - Temperature in degrees C. (Here: +0284 equals +28,4 degrees C.)
- \$01 - Logitudinal speed. (Here: +0019 equals 0,19 knots forward direction, uncalibrated values).
- \$02 - Transversal speed. (Here: +0000 equals 0 knots, + = starboard, - = port, uncalibrated values)



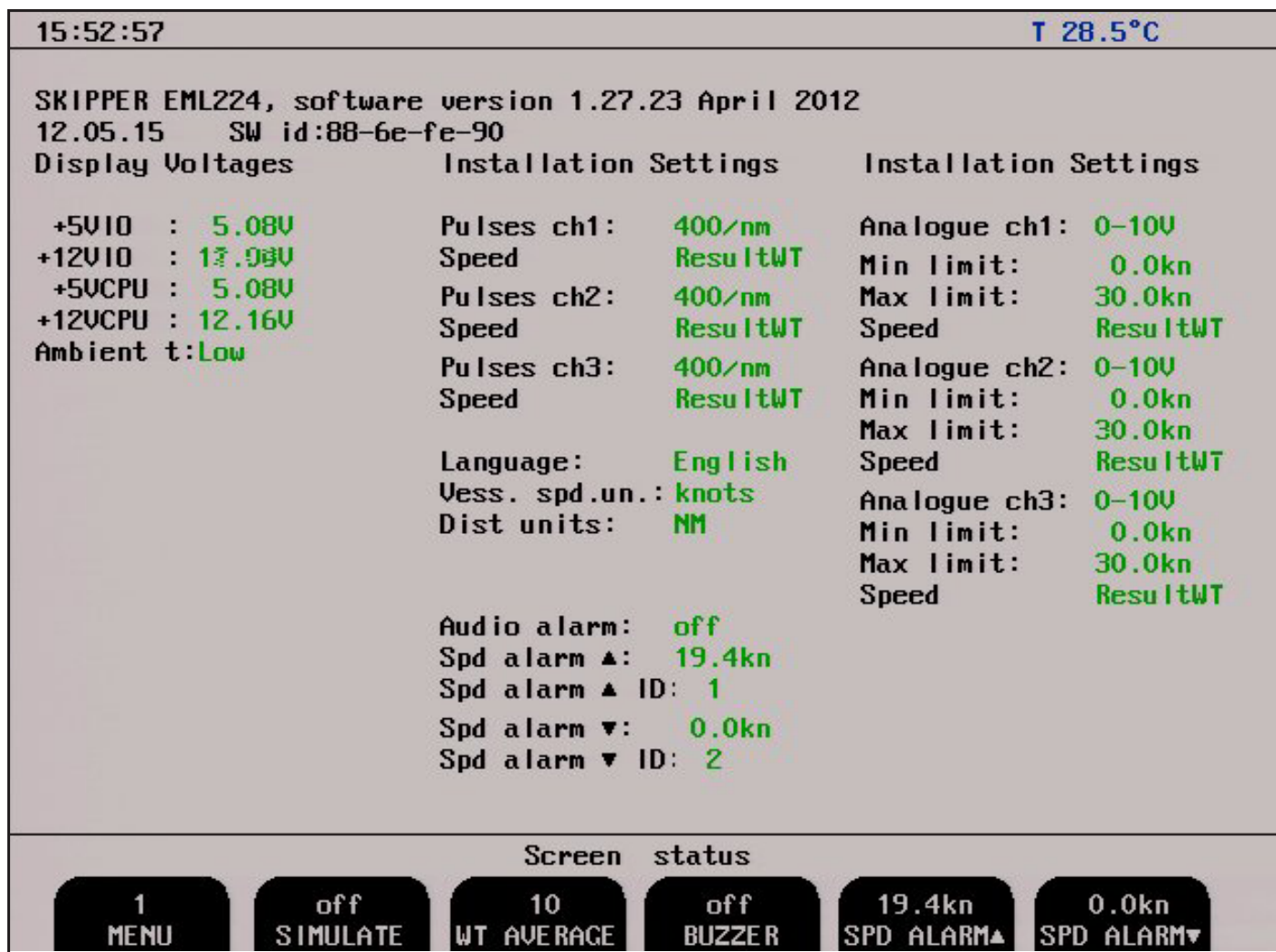

Fig. 2.8. Screen Status, Menu 1

Soft key	Name	Range/value	Default value	Description	Activate with hidden button
1	MENU	1 - 6	1	Chosen menu number 1.	
2	SIMULATE	On/off	Off	Built-in simulator on/off.	
3	WT AVERAGE	0 - 100	10	Number of individual samples to be averaged in water track mode to provide better accuracy.	Yes
4	BUZZER	On/off	Off	Buzzer alarm on/off.	
5	SPD ALARM ▲	0.1 - 38.9 kn	19.4 kn	High speed alarm.	
6	SPD ALARM ▼	0.0 - 38.8 kn	0.0 kn	Low speed alarm.	

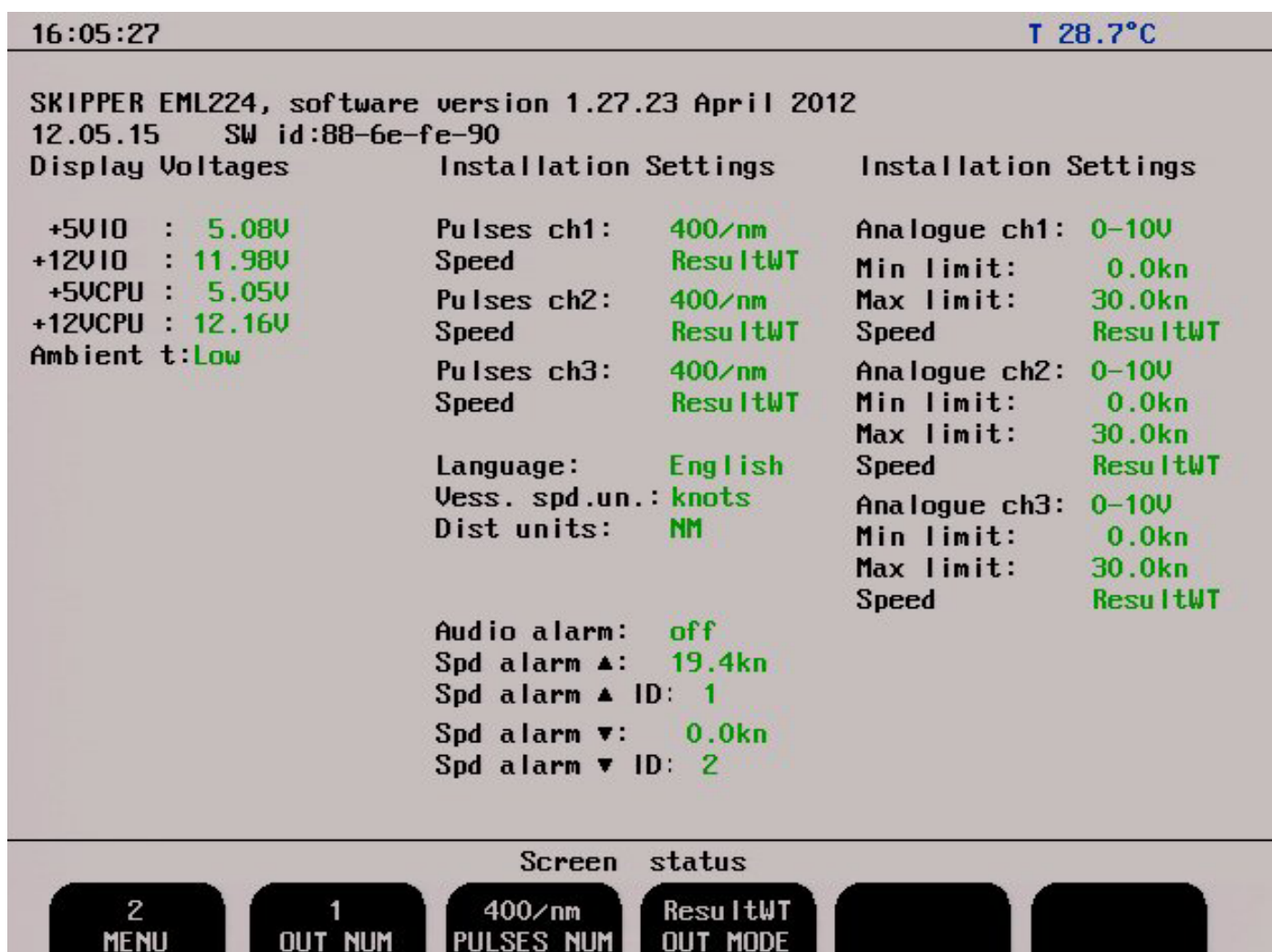

Fig. 2.9. Screen Status, Menu 2

Soft key	Name	Range/value	Default value	Description	Activate with hidden button
1	MENU	1 - 6	2	Chosen menu number 2.	
2	OUT NUM	1 - 3	1	Pulse output channel to be configured by soft keys 3 and 4.	
3	PULSES NUM	10, 100, 200, 400, (1000)/nm	400/nm	Number of pulses per nautical mile at this channel (key 2). Channel 1 and 2 are programmable with 10, 100, 200 and 400 pulses per nautical mile. Channel 3 are programmable with 10, 100, 200, 400 and 1000 pulses per nautical mile.	
4	OUT MODE	ResultWT, ForAftWT, LateralWT,	ResultWT	Speed parameter to be output at this channel (soft key 2).	
5				Not used.	
6				Not used.	

**Note:** 1000 pulses per nautical mile only on Ch 3 (OUT NUM 3).

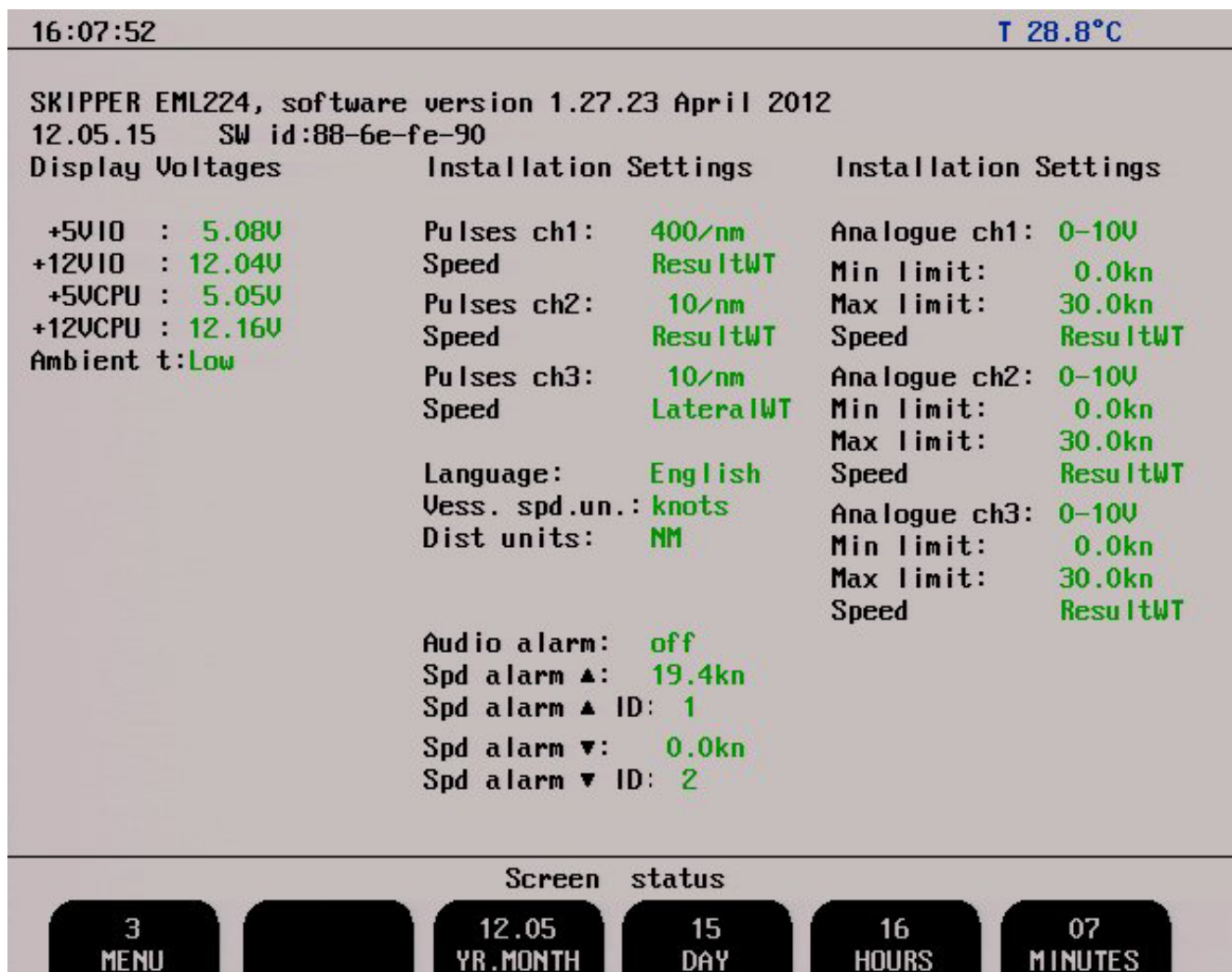

Fig. 2.10 Screen Status, Menu 3

Soft key	Name	Range/value	Default value	Description	Activate with hidden button
1	MENU	1- 6	3	Chosen menu number 3.	
2				Not used.	
3	YR.MONTH			Year and month setting.	
4	DAY			Date setting.	
5	HOURS			Hours setting.	
6	MINUTES			Minutes setting.	

**Note:** If a satellite navigator (GPS) giving UTC messages is connected to the NMEA input, the clock and calendar will be automatically updated and manual adjustment is not required.

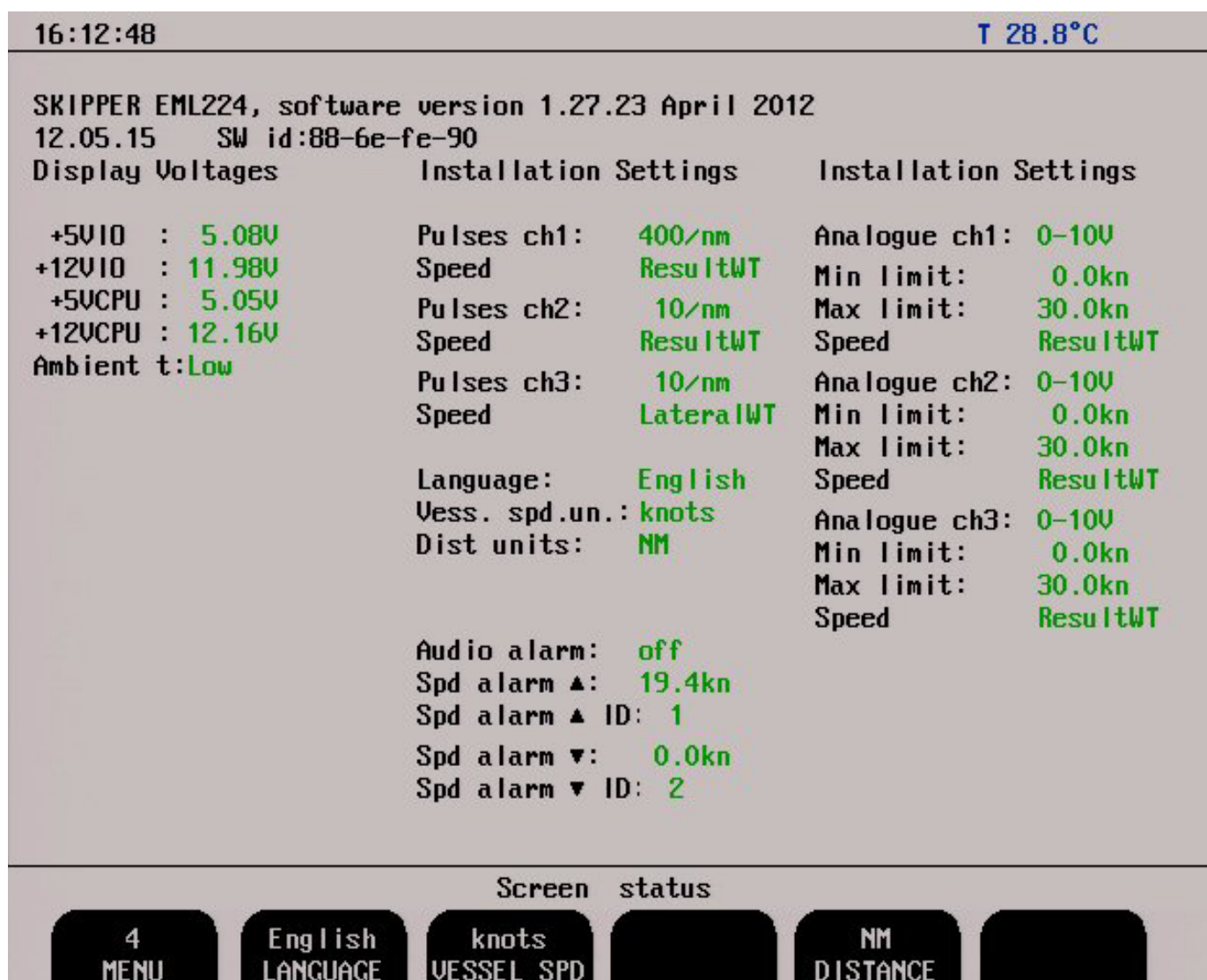

Fig. 2.11. Screen Status, Menu 4

Soft key	Name	Range/value	Default value	Description	Activate with hidden button
1	MENU	1 - 6	4	Chosen menu number 4.	
2	LANGUAGE	English, French, Spanish, Russian, German, Scandinavian.	English	Select display language.	
3	VESSEL SPD	Knots, km/h, mi/h, m/sec.	Knots	Select speed unit.	
4				Not used	
5	DISTANCE	NM, km, mi.	NM	Select distance unit.	
6				Not used.	

**Note:**

- Use soft key 1 (MENU) and encoder button to get access to screen status menu 4.



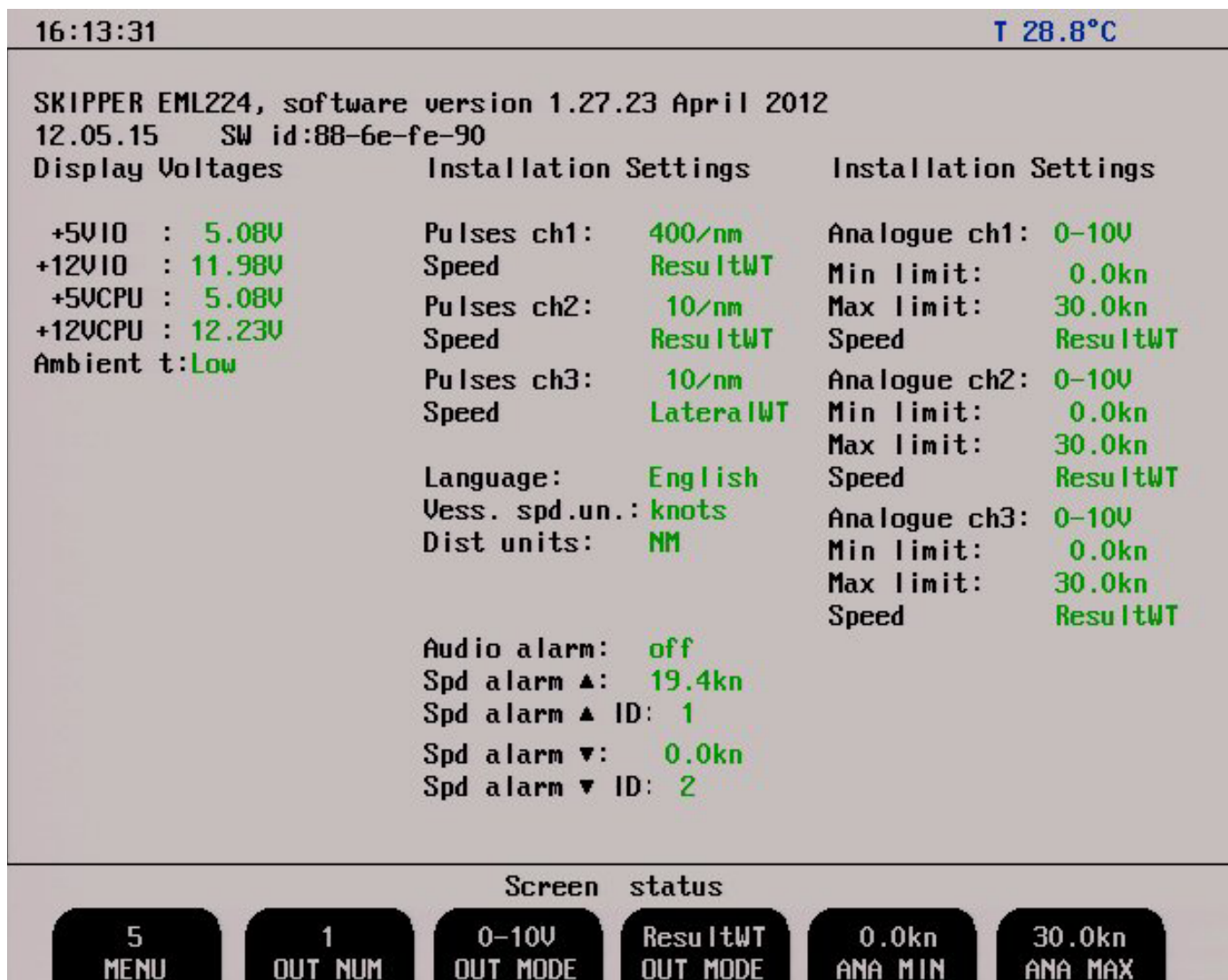

Fig. 2.12. Screen Status, Menu 5

Soft key	Name	Range/value	Default value	Description	Activate with hidden button
1	MENU	1 - 6	5	Chosen menu number 5.	
2	OUT NUM	1 - 3	1	Analogue output channel to be configured by keys 3 - 6.	
3	OUT MODE	0 - 10 V 4 - 20 mA	0 - 10 V	Output mode selection for this channel (key 2).	
4	OUT MODE	ForAftWT, Lateral/WT, ResultWT	ResultWT	Speed parameter to be output at this channel (key 2).	
5	ANA MIN	-48.6 - 48.6 kn	0.0 kn	Speed value for minimum output at this channel (key 2).	
6	ANA MAX	-48.6 - 48.6 kn	30.0 kn	Speed value for maximum output at this channel (key 2).	

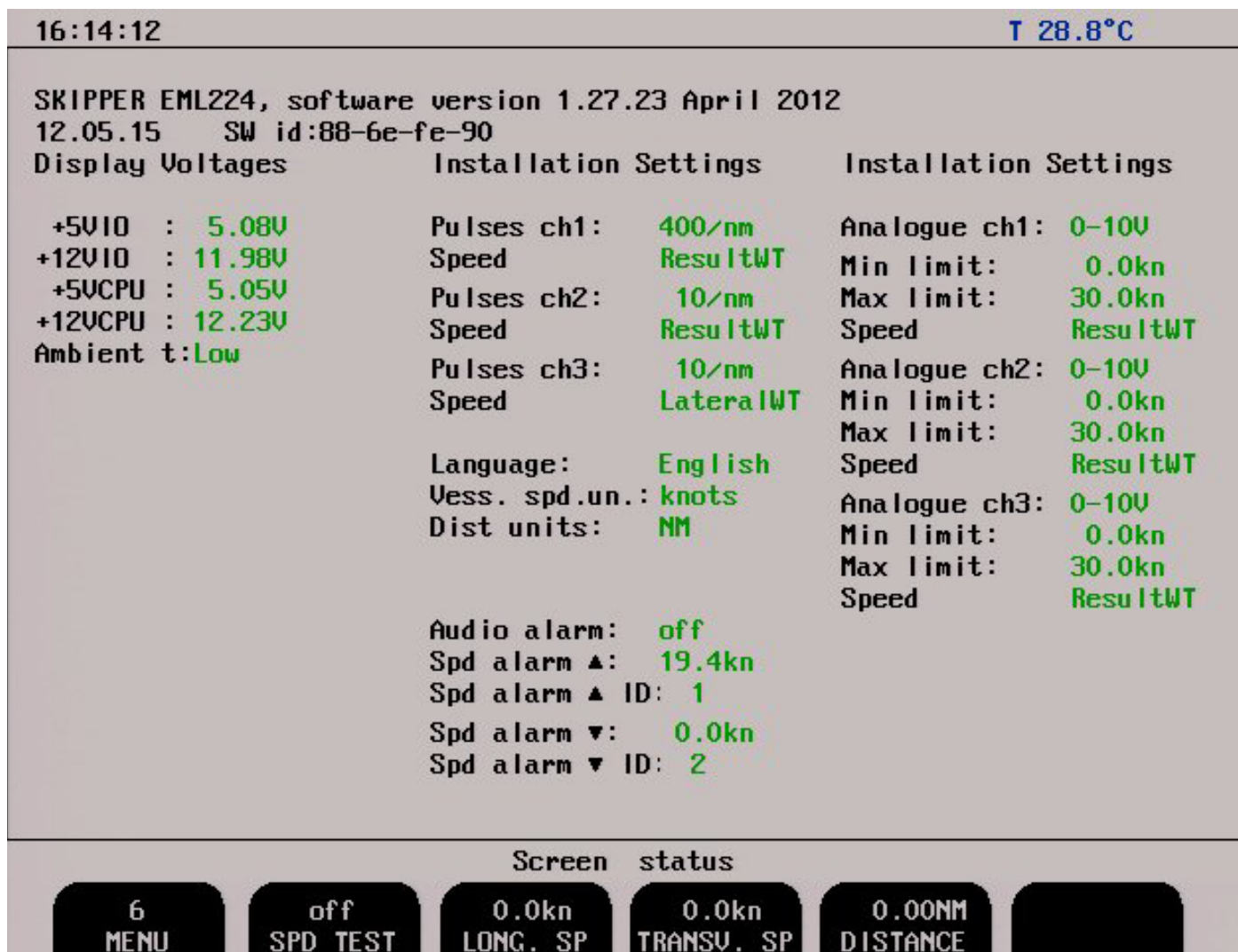

Fig. 2.13. Screen Status, Menu 6

Functions described below can be used during commissioning period to test different outputs with constant, user adjustable speed values. **Note:** When the test mode (SPD TEST) is activated, this will be indicated by flashing “TEST” label in the lower left part of the screen.

Soft key	Name	Range/value	Default value	Description	Activate with hidden button
1	MENU	1 - 6	6	Chosen menu number 6.	
2	SPD TEST	On/off	Off	Toggling test mode on/off.	Yes
3	LONG. SP	-40.0, -20.0, -15.0, -10.0, -5.0, 0.0, 5.0, 10.0, 15.0, 20.0, 40.0,	0.0 kn	Select test value of longitudinal speed.	
4	TRANSV. SP	-5.0, -4.0, -2.0, -1.0, -0.5, 0.0, 0.5, 1.0, 2.0, 4.0, 5.0,	0.0 kn	Select test value of transversal speed.	
5	DISTANCE	0.00, 9.99, 99.99, 999.99, 9999.99, 99999.99	0.00 NM	Select test value of distance.	
6				Not used	

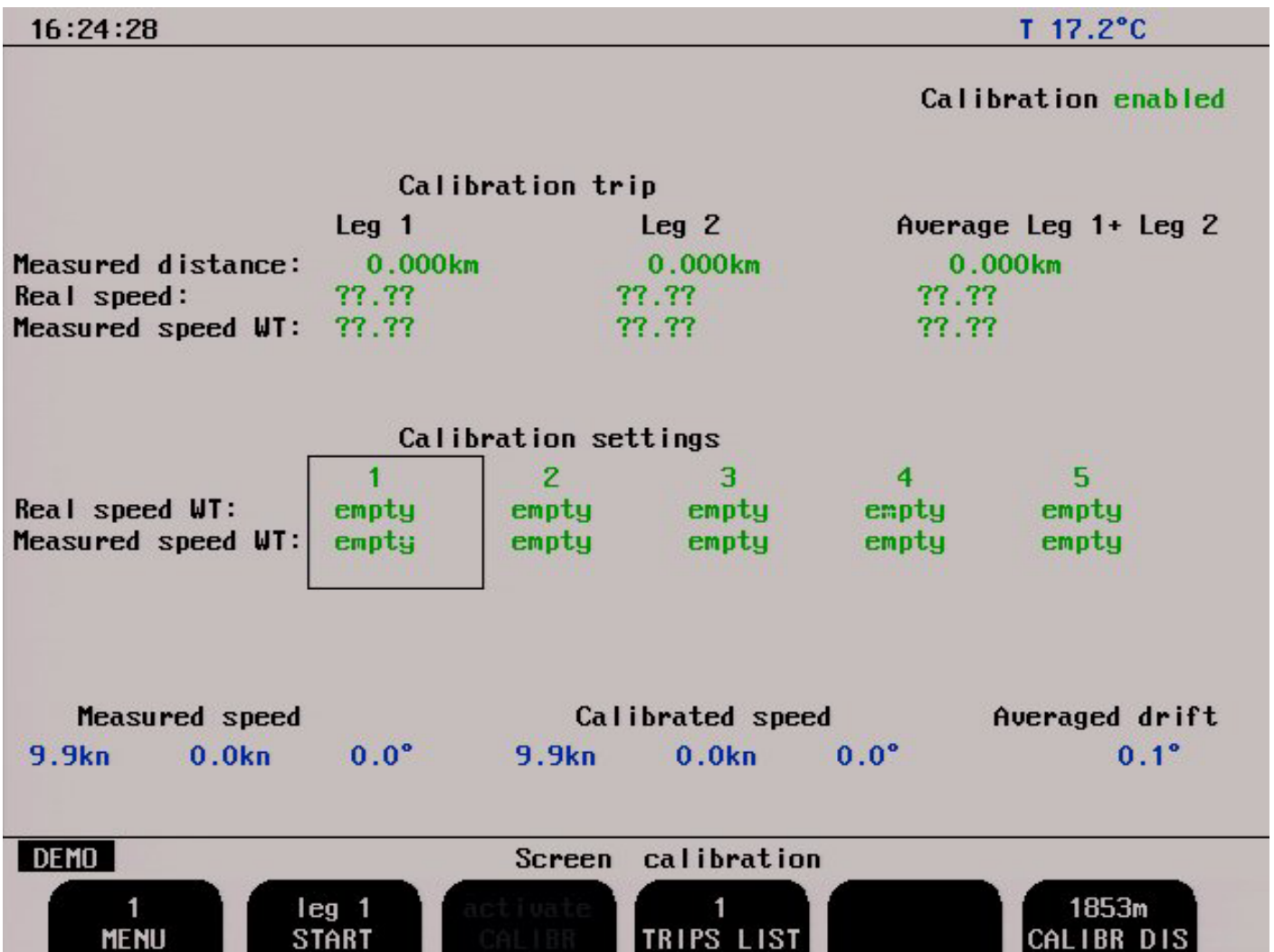

Fig. 2.14. Screen Calibration, Menu 1

Soft key	Name	Range/value	Default value	Description	Activate with hidden button
1	MENU	1 - 3	1	Chosen menu number 1.	
2	START	Leg 1 start/finish Leg 2 start/finish	Leg 1	Used to start/finish test trip.	Yes
3	CALIBR	Activate		Used to move data, collected during test trip into calibration table.	
4	TRIPS LIST	1 - 5	1	Used to list between different test trip data sets. Only one test trip is displayed on the screen at a time.	
5				Not used.	
6	CALIBR DIS	100 - 10000	1853 m	Used to adjust length of the test leg.	

**Note:** Soft key 3 (CALIBR) available (not “dimmed”) when the calibration values are within limits.

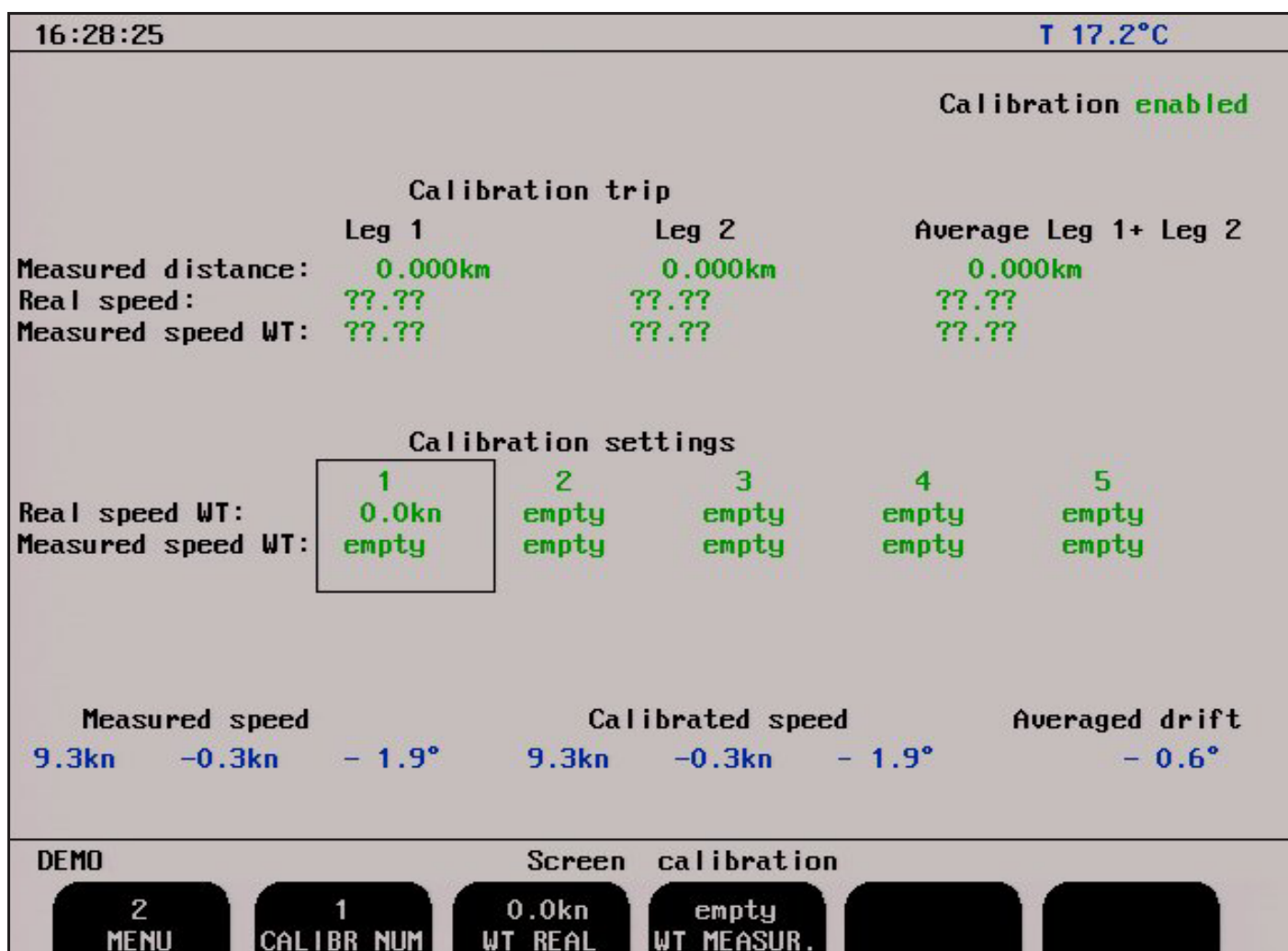

Fig. 2.15. Screen Calibration, Menu 2

Soft key	Name	Range/value	Default value	Description	Activate with hidden button
1	MENU	1 - 3	2	Chosen menu number 2.	
2	CALIBR NUM	1 - 5	1	Number of the calibration, currently available for adjustments. In the calibration table it is marked by the frame.	
3	WT REAL	Empty, 0.0 - 38.9 kn	Empty	Real ship's WT speed.	
4	WT MEASUR.	Empty, 0.0 - 38.9 kn	Empty	WT speed, measured by the system (not calibrated).	
5				Not used.	
6				Not used.	

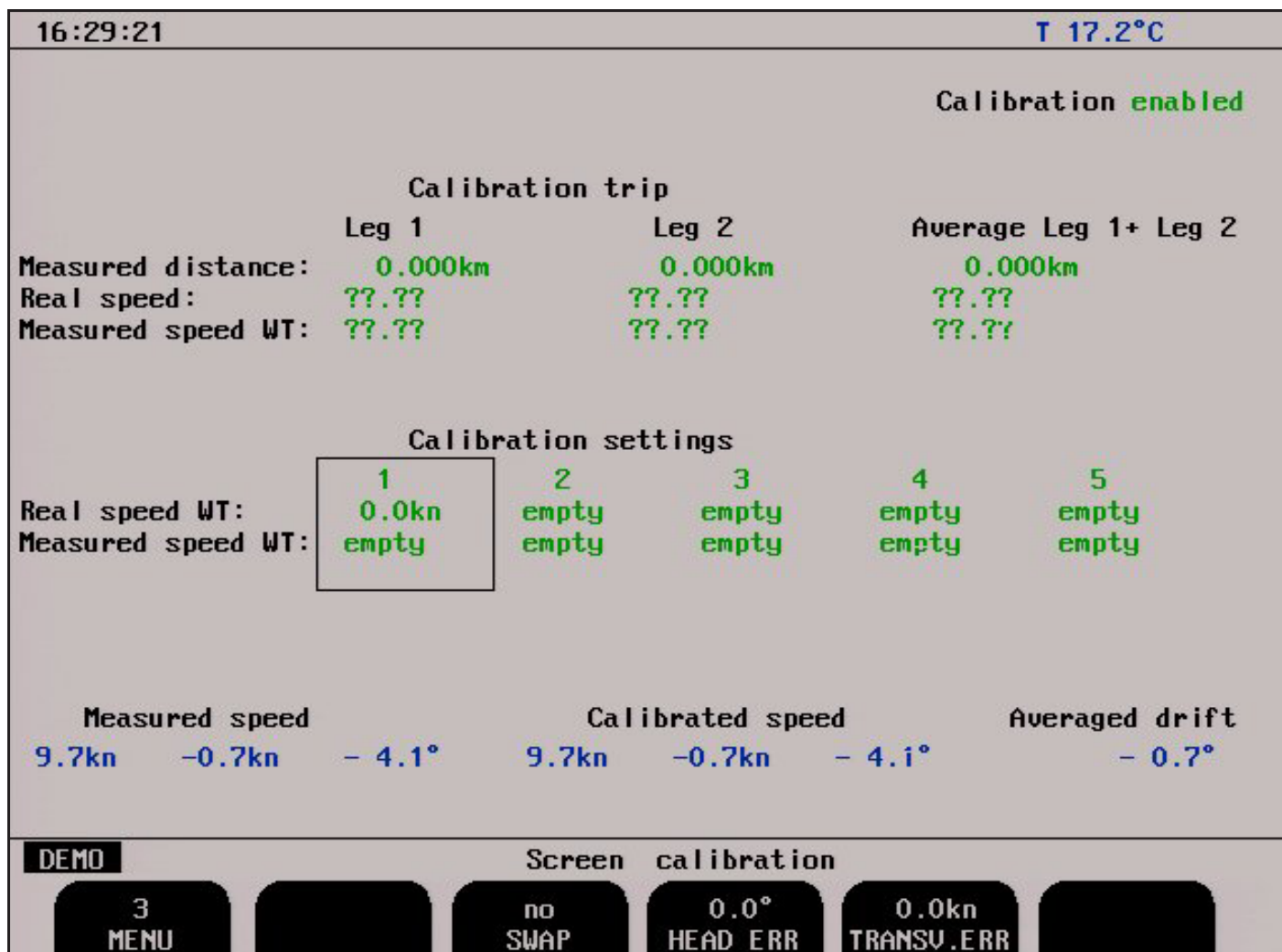

Fig. 2.16. Screen Calibration, Menu 3

Soft key	Name	Range/value	Default value	Description	Activate with hidden button
1	MENU	1 - 3	3	Chosen menu number 3.	
2				Not used.	
3	SWAP	No, p-s, f-a, p-s/f-a,	No	Sensor 180 degrees swap.	
4	HEAD ERR	0.0 - 30.0 °	0.0 °	Installation angular error correction.	
5	TRANSV. ERR	0.0 - 38.9 kn	0.0 kn	Installation transversal error correction.	
6				Not used.	



## Principal Functions

### Principles of Electromagnetic Log

The sensor of the electromagnetic log creates a magnetic field in the water. When the ship moves, the stream of water running along the hull cuts this magnetic field and generates a difference in potential between the sensor electrodes. This difference is directly proportional to the speed of the stream of water. Calibration of the log makes it possible to correct the difference between the water speed around the transducer and the speed of the ship. These differences being essentially linked to the positioning of the transducer in relation to the hull and also to the hull's shape.

### Power ON/OFF

During normal daily operation, the system may be switched off from all operation menus. This operation does not disconnect the system from the power supply, but all power consuming components are switched off. The system may be switched on again by pressing any button.

### Alarm acknowledgement

When any alarm is activated, the alarm may be acknowledged by pressing any button. An alarm can also be silenced by using a remote alarm button, but the alarm message will still be present until a button is pressed on the operator unit.

## Fixed Key Functions

### Screen Select

The SCREEN SELECT button facilitates selection of one of the five screen and softkey layouts. The 2 primary operation screens may be cycled by repeatedly pressing the SCREEN SELECT button. Access to the remaining screens is through encoder operation. The screens are cycled in an endless, bidirectional loop, e.g. turning the encoder counter-clockwise, will open the last screen after the first screen. Turning the encoder with no buttons pressed always force screen A.

### Backlight adjustment

Backlight may be continuously controlled by using the appropriate button and the encoder. Press the button and rotate the encoder until a satisfactory setting is obtained, then release the button. The settings are maintained in the nonvolatile memory, and the last settings are restored on power up. Backlight may be adjusted in both day and night vision.

### Day/Night

Day/Night vision may be selected by pressing this button. See "[Fig. 1.2. Display unit panel layout](#)" [on page 8](#).

## Key Functions

### Menu

On some screens, the leftmost soft key is used for selecting the desired menu, i.e. soft key layout within a screen. The different screens have a different number of menus, and some of the menu

functions may be available on more than one menu. Below is a list of some menu functions, not necessarily in the sequence they appear on the screens.

### **Trip Reset**

This key is used to reset the trip distance counter. See [“Fig. 2.3. Screen A” on page 11.](#)

### **Alarm Settings**

Speed alarm settings are performed from status screen, menu 1, see [“Fig. 2.8. Screen Status, Menu 1” on page 17.](#) Alarm limits are referred to the indicated speed and depth. The local alarm buzzer may be disabled from status screen, menu 1, but the external alarm relay will always operate. The only way to disable the alarms completely, is to reduce the low speed alarm to zero and increase the high speed alarm to maximum range. An active low speed alarm must be less than an active high speed alarm. Alarm limits are enforced with hysteresis.

### **Alarm ID**

Both Shallow and Deep water alarms can be uniquely identified using the ID setting. This allows alarm systems to display which type of alarm sounding.

### **Clock and Calendar Settings**

Manual clock and calendar adjustments are carried out in the status screen menu 3, see [“Fig. 2.10 Screen Status, Menu 3” on page 19.](#) If a satellite navigator giving UTC messages is connected to the NMEA input, the clock and calendar will be automatically updated and manual adjustment is not required.

### **Simulator**

The EML224 contains a built in simulator to test the screen indicators and various interface signals. The simulator may be switched on and off on status screen menu 1, see [“Fig. 2.8. Screen Status, Menu 1” on page 17.](#) When the simulator is operating, “Demo” is flashing at the bottom of the screen.

### **Status Screen**

The Status Screen shows a list of various system parameters useful for documenting system set-up and system operating status. The contents of this screen will be valuable information in situations where manufacturer support is required.

## **Nonvolatile Parameter Memory**

The system contains memory to maintain installation and user parameters like language and units of measurement selection, backlight settings, etc. These parameters are automatically restored on power up. If the user parameters have never been set, default values are used.

## **Options**

### **Repeaters/speed and distance**

Digital repeaters may be connected to the system.

## **3. User Maintenance**

---

### **Sensor Maintenance**

The sensor is virtually maintenance free, but occasional cleaning may be necessary depending on sea water conditions.

### **Operator Unit Maintenance**

The operator unit contains no user serviceable parts, and requires no maintenance apart from occasional cleaning of the front panel. Please use a soft cloth and no chemicals except cleaning alcohol.



## 4. Installation

---

### Standard System Supply

A basic EML224 system consists of the following units:

- Display/Operator unit.
- Electronic unit.
- Sea valve with hull fitting sensor.

See “[Fig. 11.1. EML224 System overview](#)” on page 57.

### Hull Fitting

Please see installation manuals (also found on our web site [www.skipper.no](http://www.skipper.no)) for chosen sea valve or tank solutions for dimensions and hull fittings.

### Sensor Location

To facilitate the calibration procedure, the sensor should be installed close to the bulb or the stem of the ship, avoiding areas where it may be damaged by the anchor chain. It is necessary to select a part of the hull that is submerged under all load and speed conditions.

- The electronic unit have to be installed in a dry place.
- The sea valve with sensor can be installed in a water tank, but it is not recommended. SKIPPER will not be responsible if it is necessary to empty a tank in order to access the sensor for service purposes.
- It is necessary to position the sensor on a flat, horizontal hull section which is large enough to ensure a laminar water flow for all angles of drift.
- If such a flat section is not available, the shipyard must construct a suitable bed.
- If the vessel is designed with a box keel, this can be used for installation of the sensor. In this case, suitable hull fitting may be ordered from SKIPPER.

Before hull fitting installation procedure is initiated, always check that the sea valve can be properly operated and the sensor removed in the location selected. The required clearance to operate the valve and remove the sensor is shown in the installation manual for the sea valve solution. See Skipper web site, [www.skipper.no](http://www.skipper.no) for detailed information.

### Part Positioning and Welding

Please see the installation manual for the hull fittings. Installation may differ between the different sea valve and tanks solutions available.

- **Note:** Do not paint the protruding part of the sensor and electrodes.

## The Electronic Unit

The electronic unit contains the power supply PCB for the transducer. It must be installed fairly close to the hull fitting as the standard cable is 40 meters. The unit should be fitted on a vertical surface in a dry area. See [“11. Appendix” on page 56](#) for miscellaneous installation drawings.

### Sensor/Electronic Unit interconnection

- The sensor is connected to the electronic unit with the attached cable.
- The outer cable screen must be connected to the EMC cable gland. See [“Fig. 11.5 Cable gland connection” on page 61](#).
- The EML log sensor cable can be cut or extended.

Power supply for the Electronic Unit is 115/230 V AC and/or 24V DC.

The circuit board in the electronic unit is equipped with several LEDs indicating the state of various voltages and signals. Following list show the expected status of the LEDs. Location is indicated in the wiring diagram [“Fig. 4.2. Sensor /Electronic Unit, Wiring diagram.” on page 31](#).

LED	Colour	Signal	Description/Function
LD100	Green	Power	Voltage indicator. (Flashing at 2 Hz or greater, with the field inducting current). LD100 = Sensor field generation, goes "OFF" when field in sensor is active.
LD200	Green	Data from sensor	On and flashing in accordance with data traffic. LD200 = Data received from sensor. "On" connection OK. No data "Off" when data is received.
LD300	Red	NMEA in	Flashing in accordance with data traffic. LD300 = Receive NMEA messages from external systems. "OFF" when message is received.
LD301	Green	NMEA out	Flashing in accordance with data traffic. LD301 = Transmit NMEA messages to external systems. "On" when message is transmitted.
LD302	Green	Data to sensor	On and flashing in accordance with data traffic. LD302 = Data transmitted to sensor, "ON"connection OK, no data "OFF" when data is transmitted

# Transducer/Electronic Unit PCB

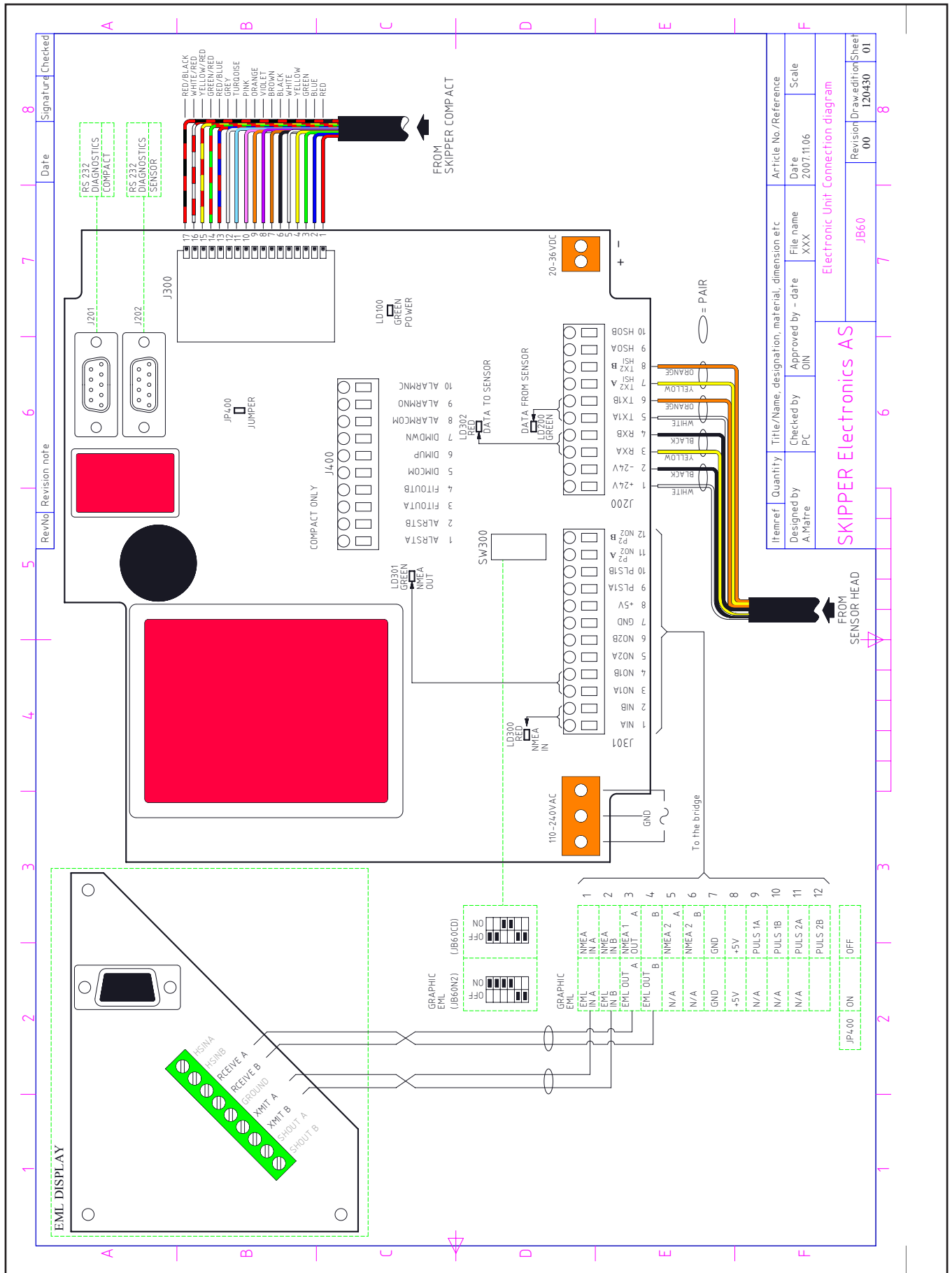

Fig. 4.2. Sensor /Electronic Unit, Wiring diagram.

## Operator Unit Installation

Select a position to provide free view of the panel as well as easy access during operation and service. The operator unit may be mounted flush in a panel or directly onto a bulkhead. “[Fig. 11.3 Outline dimensions Display Unit](#)” on page 59 shows the operator unit along with the main installation dimensions. If the unit is to be flush mounted, the shown cut-out and recession depth dimensions must be observed. Remember to leave room in front of the unit to open the door a full 90°.

### **Do not perform installation work with system power applied!!**

Cables are fed through the appropriate cable glands as follows:

- The cable from the transducer should normally occupy the left gland.
- The right gland is used for power supply connection.
- Whereas the centre ones are used for any interface signals connected.

### **115/230 V on Combo Terminal board inside Display Unit**

Power supply may be either 115 V/230 V AC and/or 24 V DC. Power consumption is appx. 50 W at 24 V, appx. 70W at 115/230 V.

If the AC power system is 115 V, EML224 may be prepared for 115 V AC by re-connecting the connectors J102, J103 as shown in “[Fig. 4.3. Voltage selection connectors and fuses, Terminal Board, EML224 Operator Unit.](#)” on page 33.

This diagram also shows position of fuses for 115/230 V AC and 24 V DC. These fuses are normal 5 x 20 mm slow blow glass fuses.

Supply voltage	Fuse	Value
230 V AC supply	FS100, FS101	0.5 A
115 V AC supply	FS100, FS101	1.0 A
24 V DC supply	FS102	3.15 A

When the installation is complete, and power is connected to the operator unit, the appropriate power switch by the power terminals is switched on. For daily operation, these switches may stay on and the unit is switched off by pressing the “SYSTEM off” button on screen A or screen B. The unit is switched on by pressing any button.

Both 115/230 V AC and 24 V DC power may be connected and switched on at the same time. If one of these supplies shuts down, changeover is automatic.

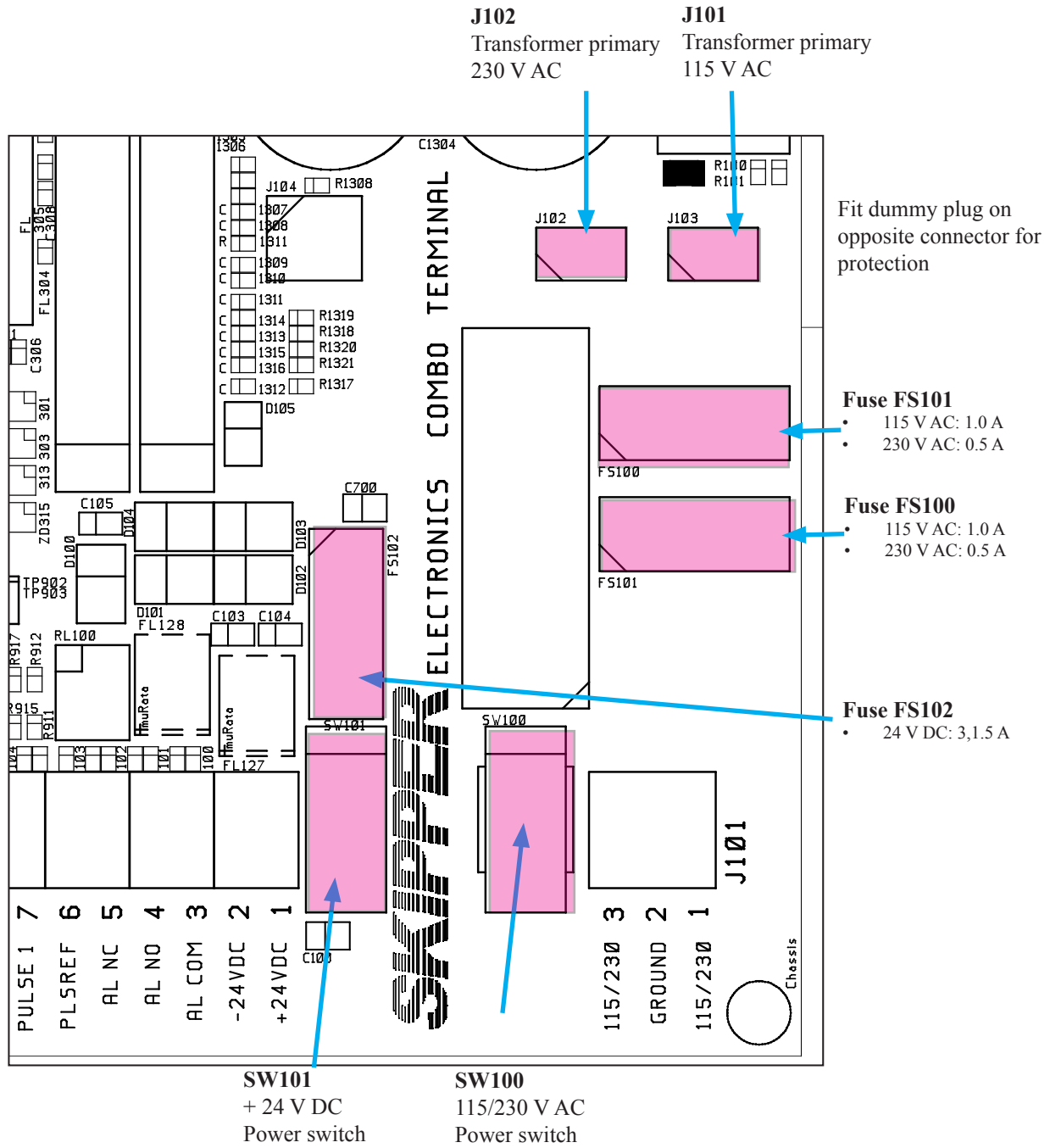

Fig. 4.3. Voltage selection connectors and fuses, Terminal Board, EML224 Operator Unit.

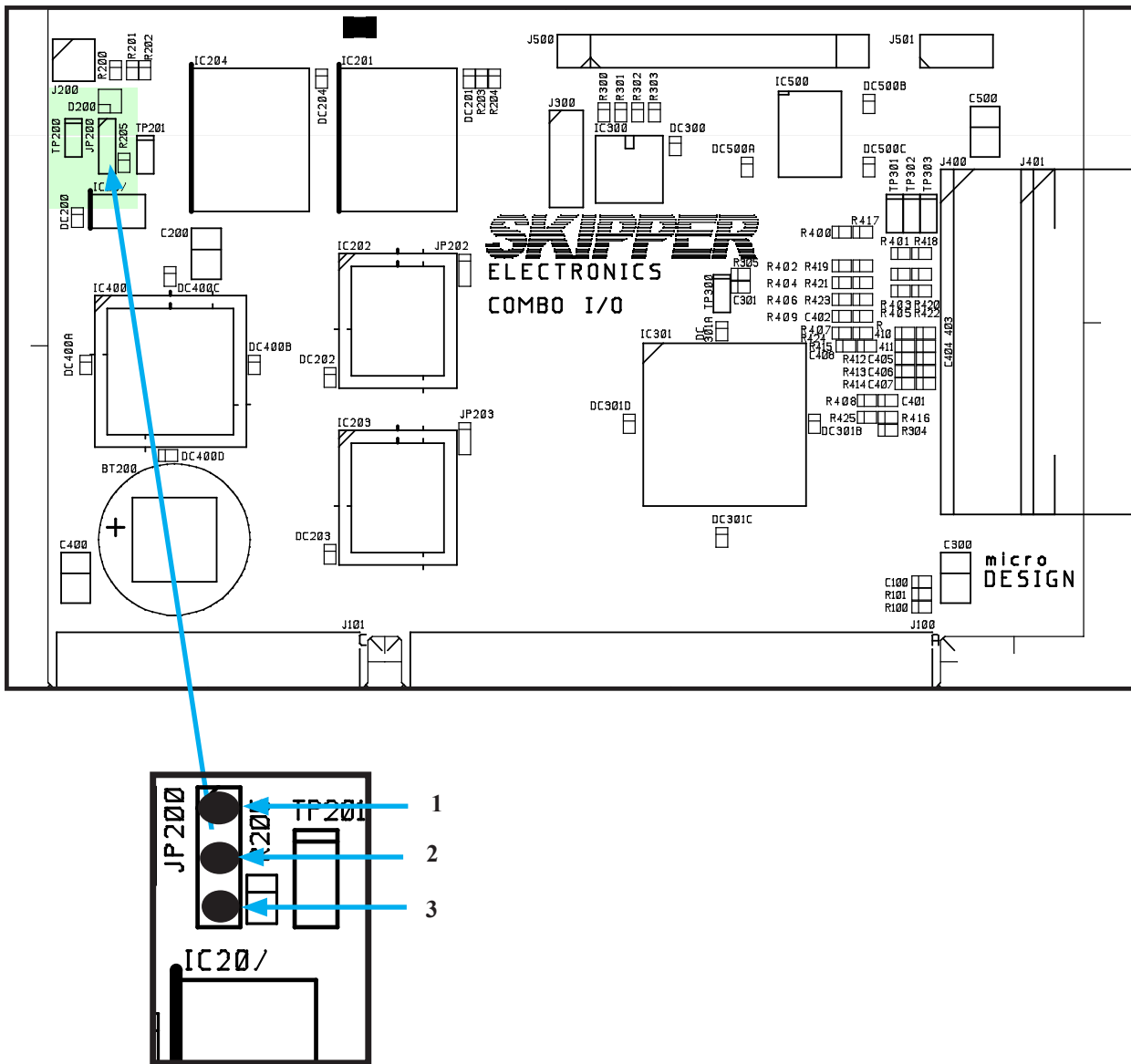
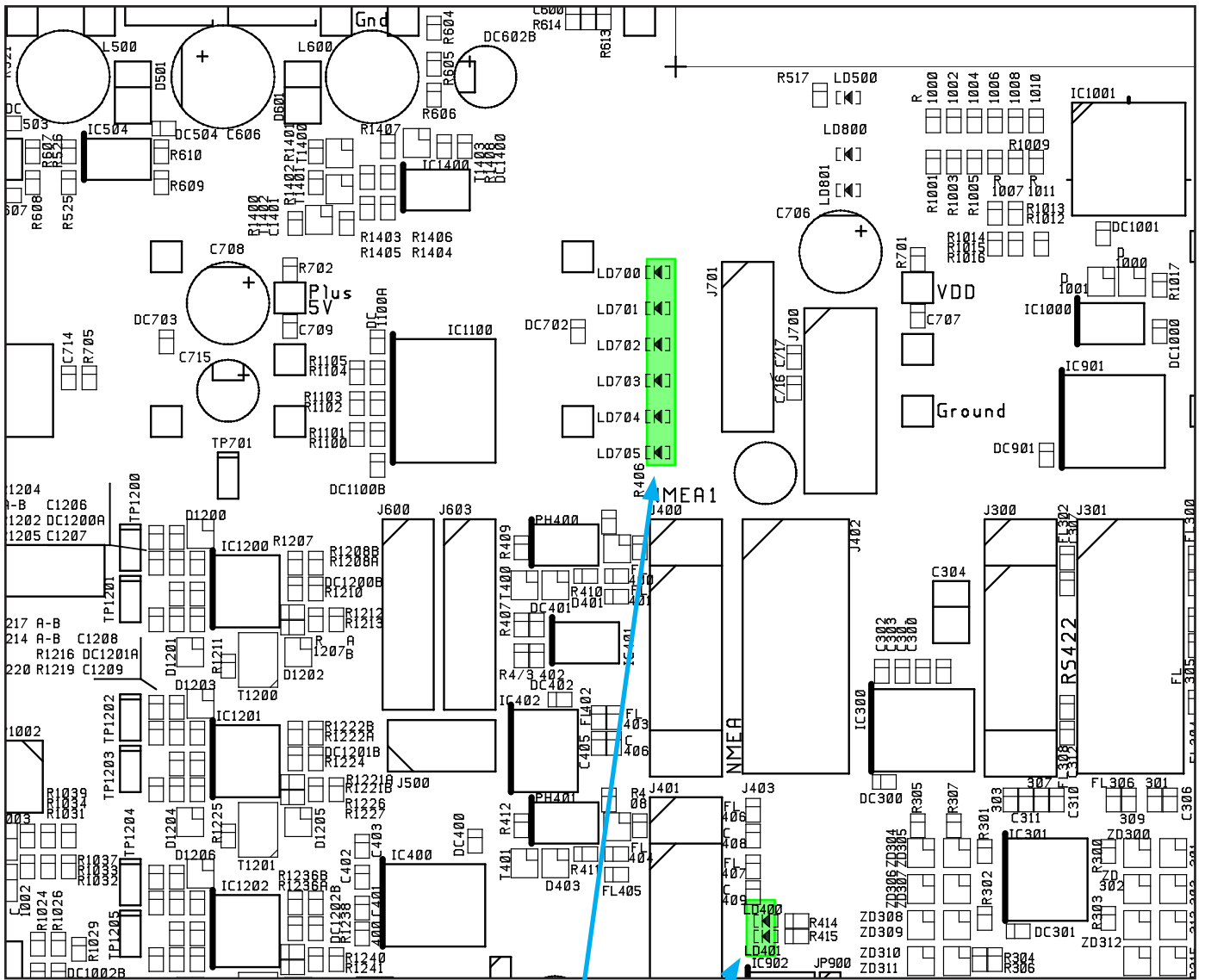

Fig. 4.4. Back-up Battery Jumper, I/O Board.

### Back-up Battery Jumper JP200

After installation is complete and system power is applied, it is necessary to connect the battery to provide power to the circuitry containing user parameters at a system power failure. Refer to Fig. 4.4 above for the correct setting of the battery jumper “ON” position 2-3. This jumper should be set to the “OFF” position 1-2 only during extended unit storage periods. The battery is active only when no power is applied to the power terminals.



**Fig. 4.5. Function LEDs, Terminal Board.**

**Power indication and function LEDs**

The following LEDs are located on the terminal board:

LD400	NMEA signal activity on receive input 1.
LD401	NMEA signal activity on receive input 2.
LD700	+5 V#1/VCC (Board external and CPU).
LD701	+12 V#1/VDD (Board external).
LD702	+5 V#2 (Board internal).
LD703	+12 V#2 (Board internal).
LD704	-12 V.
LD705	-5 V.

# Interfacing.

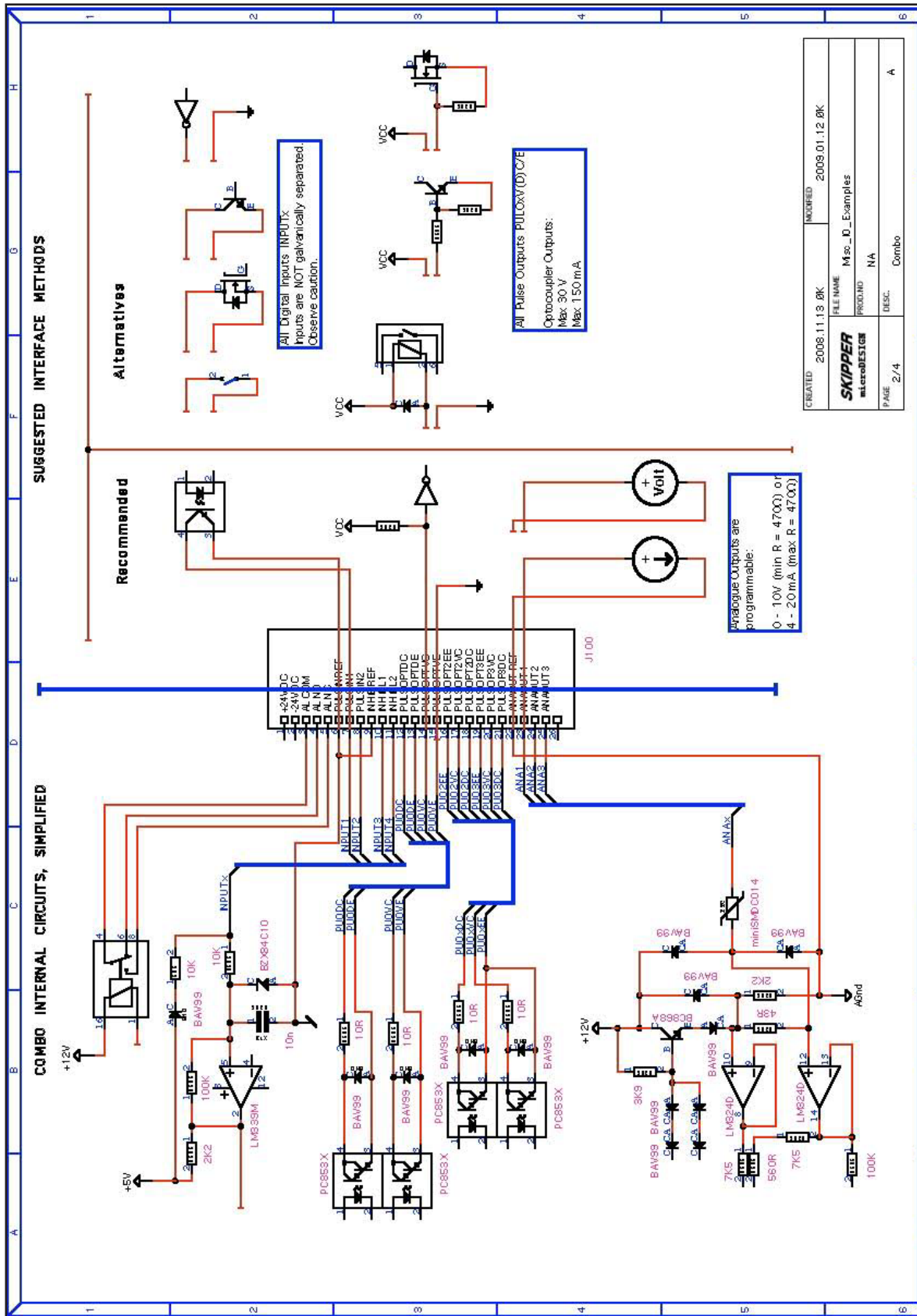

Fig. 4.6. Input/Output Circuitry.



## Interfacing

### Alarm Relay

An alarm relay is provided for interconnection to external alarm systems. This relay is normally energized, and is released by alarm conditions or power failure/power off. See “[Fig. 4.7. Alarm interconnection](#)” on page 38 and “[Fig. 11.2. Terminal board connections](#)” on page 58. The terminals have the following significance:

Name	J100 pin no	Description
ALCOM	3	Common terminal.
ALNO	4	Normally open contact.
ALNC	5	Normally closed contact (Normal = “No alarm” condition).
INHIBREF	9	Reference for remote alarm reset.
INHIB2	11	Remote alarm reset.

### Log Pulse Outputs

Pulse output terminals are as follows:

- Each group of pulse outputs are galvanically separated. All pulse outputs are opto coupled.
- The opto couplers may be used for any pulse rate.
- The pulse rates and velocity vectors to output are programmable in “[Fig. 2.9. Screen Status, Menu 2](#)” on page 18.
- Possible settings are 10/100/200/400/1000 (1000 on Ch 3 only, OUT NUM 3).

Name	J100 pin no	Description
OPT3DC	21	Optocoupler 3, direction collector.
OPT3VC	20	Optocoupler 3, velocity collector.
OPT3EE	19	Optocoupler 3, common emitters.
OPT2DC	18	Optocoupler 2, direction collector.
OPT2VC	17	Optocoupler 2, velocity collector.
OPT2EE	16	Optocoupler 2, common emitters.
OPTVE	15	Optocoupler 1, velocity emitter.
OPTVC	14	Optocoupler 1, velocity collector.

Opto coupler direction output, Transistor Off = AHEAD or STARBOARD.

### Analogue Interfaces

EML224 is equipped with 3 analogue outputs to supply analogue repeaters or other equipment with analogue inputs. The signals are galvanically connected to the EML224. Standard range is 0 - 10 V or 4 - 20 mA. The velocity vectors and output modes are programmable from status screen, menu 5, see “[Fig. 2.12. Screen Status, Menu 5](#)” on page 21.

Name	J100 pin no	Description
ANAOUTREF	22	System ground, common negative reference for analogue outputs.
ANAOUT1	23	Analogue output #1.
ANAOUT2	24	Analogue output #2.
ANAOUT3	25	Analogue output #3



**Fig. 4.7. Alarm interconnection**

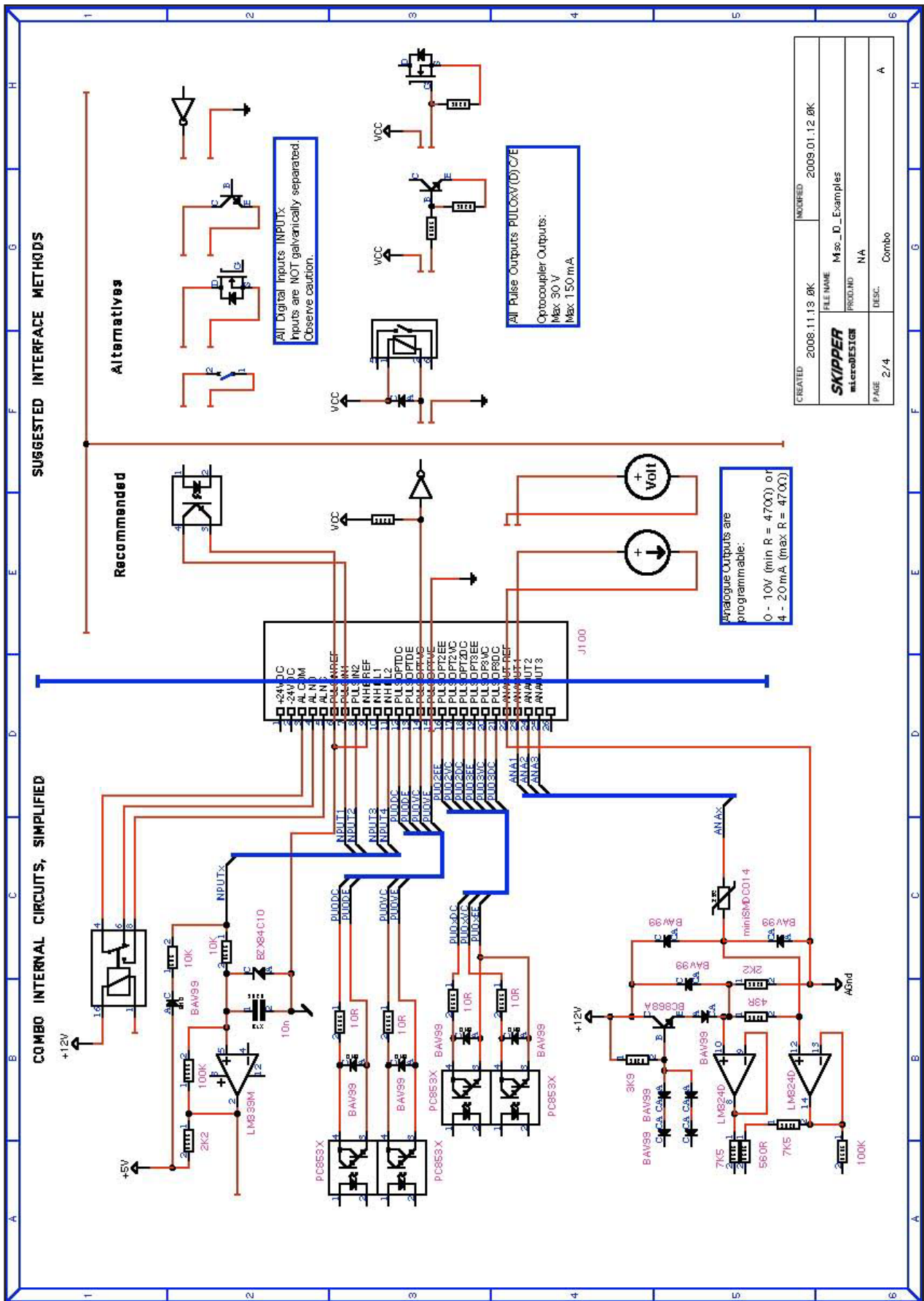

Fig. 4.8. Misc IO examples

## NMEA interface

The NMEA outputs provides NMEA 0183 format speed information for other equipment with NMEA 0183 inputs. Standard COM settings is 4800 baud, 8 bit, no parity. Several messages may be selected on COM Screen and the enabled messages are transmitted every second. See [“Fig. 2.5 A. Screen Com, Menu 1” on page 13](#) and [“Fig. 2.6. Screen Com, Menu 2” on page 15](#).

The NMEA inputs accept position, heading and UTC time messages from various talkers. The two inputs provided may be connected to different talkers, and both data streams will be received. There are two outputs that each will drive up to 10 standard NMEA 0183 listeners.

See [“NMEA Setup” on page 41](#) for a complete list of transmitted and received messages.

Also see [“Fig. 5.1 9 Pin D-Type NMEA connector XJ402 in cabinet front” on page 42](#) for pin connections.

## Options

### Repeaters

- Analogue or digital speed and distance repeaters may be connected.
- SKIPPER IR300 speed, and/or SKIPPER CDLR distance repeater may also be connected.
- Interface NMEA 0183.

## External Interface Ports

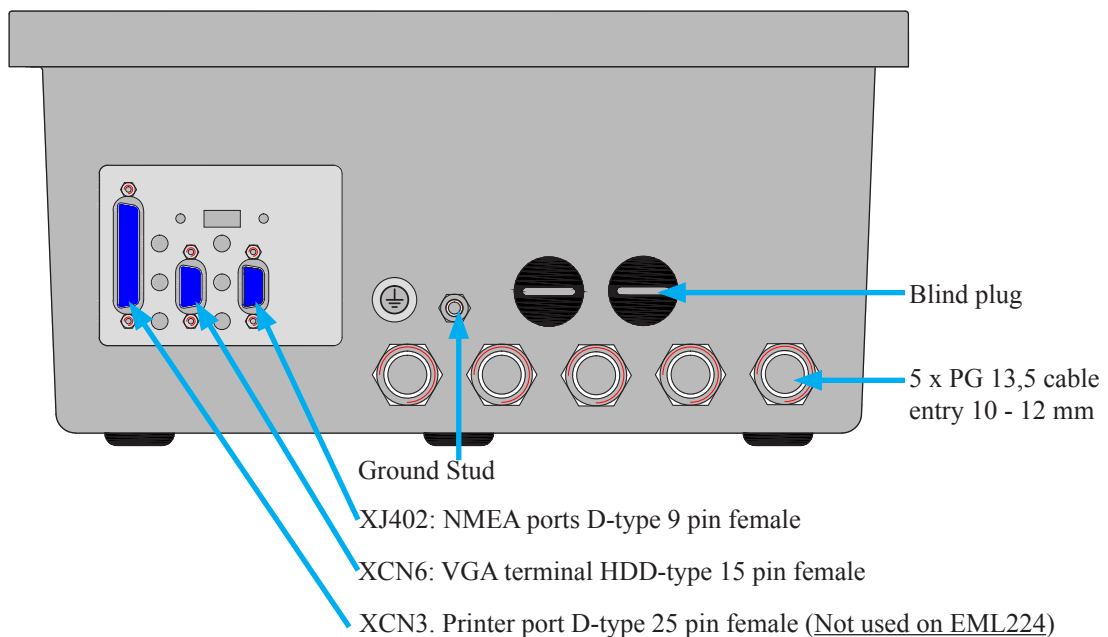

**Fig. 4.9 External Interface Ports**

## 5. Start-up and system adaption

### Analogue Outputs and Log Pulse Outputs Range Selection

From “[Fig. 2.9. Screen Status, Menu 2](#)” on page 18 it is possible to set number of pulses per nautical mile (p.p.n.m.) for the 3 available contact closure output channels (Ch):

Channel number	Pulses per nautical mile
1	10, 100, 200 or 400.
2	10, 100, 200 or 400.
3	10, 100, 200, 400 or 1000.

(The selected value for each output is shown in status screen).

Minimum and max limits for the analogue outputs may be set to:

- Maximum speed -48/+48 knots corresponding to 10 V or 20 mA.
- Minimum speed -48/+48 knots corresponding to 0 V or 4 mA.

### Language and Units of Measure

From status screen “[Fig. 2.11. Screen Status, Menu 4](#)” on page 20 it is possible to select different languages and units of measure for the screen and printer character strings.

The available languages are:

- English, French, Spanish, Russian, German and Norwegian.

Units of measure may be selected for:

- Vessel speed: knots, km/h, miles/h, m/s.
- Distance: nm, km, miles.

### NMEA Setup

Com screen is used for verification of received and control of transmitted NMEA messages. The baud rate may be set to 1200, 2400, 4800, 9600, 19200, 38400, 57600 and 115200, 4800 being the more common. When a NMEA talker is connected to one of the EML224 inputs, all received messages will be displayed on the screen. If no messages are displayed, check the signal polarity and the baud rate. The following messages are accepted for input to EML224 and interpreted by the program. The talker identifier is ignored:

#### Time

Universal Time	ZZU,xxxxxx
Universal Time & Local	ZLZ,xxxxxx,xxxxxx,-xx
Day, Month, Year	ZDA,xxxxxx,xx,xx,xxxx,-xx

The time values will be indicated in the upper left corner of the screen, example: 11:43.

**Position**

Geographical Lat/Lon	GLL,xxxx.xx,N,xxxxx.xx,W
Geographical Fix, present	GXP,xxxxxx,xxxx.xx,N,xxxx.xx,W,cccc,x
Omega Fix, present	GOP,xxxxxx,xxxx.xx,N,xxxx.xx,W,cccc
Loran C Fix, present	GLP,xxxxxx,xxxx.xx,N,xxxx.xx,W,cccc
GPS Position	GGA,xxxxxx,xxxx.xxx,N,xxxxx.xxx,W,x

The position values will be indicated on top of the screen, right side, example: E059° 13.12' N010° 57.34'

**Heading**

Heading, true, present	HDT,xxx.,T
Heading, magnetic, present	HDM,xxx.,M
True heading and status	THS,x.x,a*hh<CR><LF>
Heading, compass	HCC,xxx.

The heading values will be indicated on top of the screen, right side, example: 123.0°.

**Composite**

Loran C specific	RMA,a,xxxx.xx,N,xxxxx.xx,W,,,xx.x,xxx.,,*xx
GPS, Transit specific	RMC,xxxxxx,a,xxxx.xx,N,xxxxx.xx,W,xx.x,xxx.,,xxxxxx.,,*xx
Vessel Identification	IMA,aaaaaaaaaaaa,aaaxxxx,xxxx.xx,N,xxxxx.xx,W,xxx.x,T,xxx.,M,xx.x,N

The composite values will be indicated on different positions on top of the screen, depending on message type.

**EML224 transmitted (originated) NMEA 0183 messages**

<b>VHW</b>	Boat Speed and Heading	\$VDVHW,,,,,x.x,N,x.x,K*hh<CR><LF>
<b>VLW</b>	Distance Travelled through the water	\$VDVLW,x.x,N,x.x,N*hh<CR><LF>
<b>VLW IEC07</b>	Dual ground/water distance	\$VDVLW,x.x,N,x.x,N,x.x,N,x.x,N*hh<CR><LF>
<b>VBW</b>	Dual ground/water speed	\$VDVBW,x.x,x.x,A,x.x,x.x,A,x.x,A,x.x,A*hh<CR><LF>
<b>MTW</b>	Temperature	\$VDMTW,x.x,C,*hh<CR><LF>
<b>ALR</b>	Set alarm state	\$VDALR,hhmmss.ss,xxx,A,A,<Alarm message>*hh<CR><LF>

All data fields are free format. Values will be preceded with sign as needed ( e.g “-“ = Astern, Port)  
\*hh = Checksum

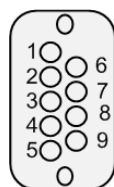

NMEA IN: Pin 1-2, RCV1 A, B  
 NMEA IN: Pin 6-7, RCV2 A, B  
 NMEA OUT: Pin 4-5, XMT1 A, B  
 NMEA OUT: Pin 8-9, XMT2 A, B

**Note:** Connector seen from outside.

**Fig. 5.1 9 Pin D-Type NMEA connector XJ402 in cabinet front**



## 6. Calibration procedure

Speed logs are calibrated in the factory to give reasonable results after installation, however installation and hydrodynamics vary from vessel to vessel. It is therefore necessary to calibrate speed logs once in place.

SKIPPER speed logs have two parameters that need to be corrected by calibration.

1. Angular sensor installation error (heading error).
2. Speed variations due to drag or mounting tilt.

### 1. Heading Error



The heading error parameter corrects for an angular offset in mounting. This offset will result in a rotation of the measurement axes. The resultant speed will be unaffected, but the longitudinal and transversal components will be incorrect. An offset will result in the vessel typically showing too much transversal speed, but may also result in speed calibration failing (i.e. initial calibration fails when further points are added). This offset will show itself as an averaged drift on the calibration.

**Reducing Heading errors.** New generation sea valves can be manually adjusted to ensure the sensor is correctly aligned. Alignment and heading offset are directly connected. To minimise the offset, the sensor should be mounted pointing ahead

- **Tank mountings** have ahead marks on both the tank and the sensor insert.
- **Sea valves** have either a mark on the top flange (DL850 540 retro fit system) or a flat mark on the port side of the pole which when a flat object is placed against this, will point fore/aft (Figure 6.1).

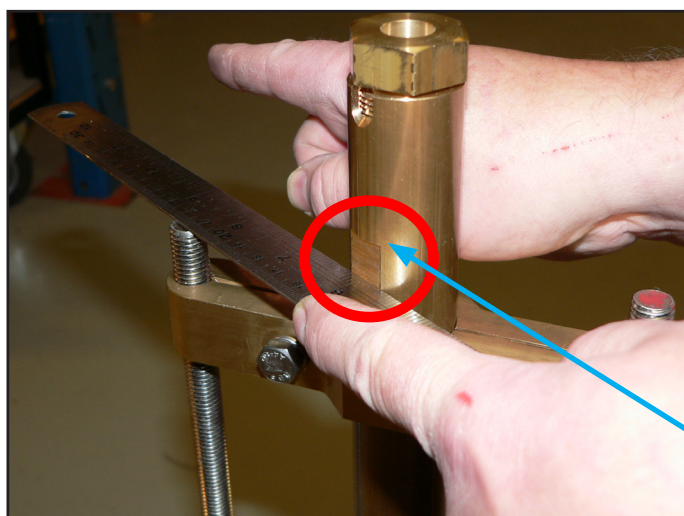

A flat object points fore/aft.

**Fig. 6.1** Sea valve alignment

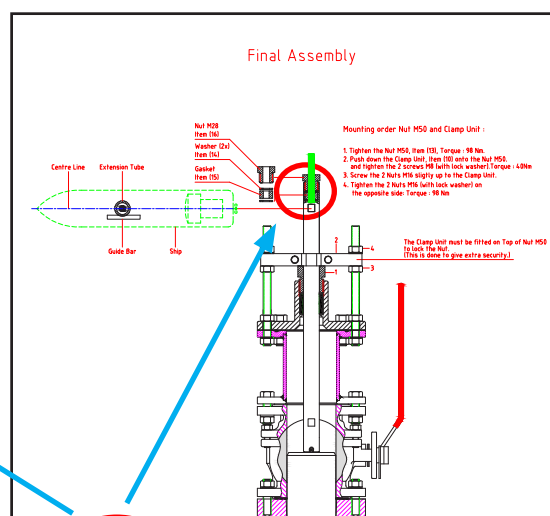

The flat side should be on the port side.

## 2. Speed variations due to drag or mounting tilt.

Every vessel will drag some water when it moves. This occurs over the whole hull. As you move further from the hull, the effect of the ships movement gets less. As the vessel moves at different speeds, the hydrodynamics of the vessel may change. In most cases the drag is even over the whole range of the vessel.

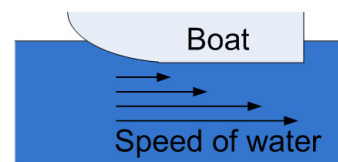

Speed logs that measure on the surface of the vessel (such as EML) are more affected by this factor than sensors that measure remotely (Doppler). The calibration variation is usually less on remote sensors.

As the calibration factors can vary at different vessel speeds, it is possible to calibrate at several speeds. It is typically necessary with only one high and one low speed. Speed logs with speed over ground can be compared with GPS speed over ground in stable conditions. However speed through water measures the influence of currents on the vessel, which cannot normally be measured on any other system. It is therefore important that full calibration is performed at least once for speed through water.

### Calibration routine:

As previously explained, there are two factors to be calibrated, heading error and speed variations. Speed through water can be approximated, but should be calibrated by sailing on opposite courses to get an accurate value.

All calibration functions are located on the **Calibration** screen. In order to select this screen, press “screen select” button in the lower row of the panel buttons and while keeping it pressed, turn encoder until desired screen appears on the display.

### Activation of the hidden menus

To avoid accidental access to the internal settings, all calibration functions are disabled during normal operation. In order to activate them, do the following:

- Open front door of the cabinet and find a “hidden” key on the component side of the keyboard PCB (upper/left corner of the PCB).
- Press key mentioned above and keep it pressed for 2-3 seconds, until “Calibration **enabled**” message is observed in the right/upper corner of the screen. The text on the START soft key will change colour from grey to white, which indicates availability of the corresponding functions.

“Hidden” button

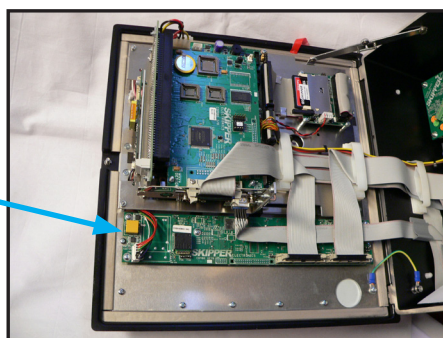

**Note:** After calibration is finished, disable access to the calibration functions simply by pressing the key again. Calibration mode is also disabled after a power recycling.

### Step 1. Heading error correction:

The vessel sails a steady course in calm waters and the user reads the resultant angle (averaged drift). This is entered into the system using the **Head err** button and encoder on menu 3, and adjusted until the **averaged drift** angle is zero.

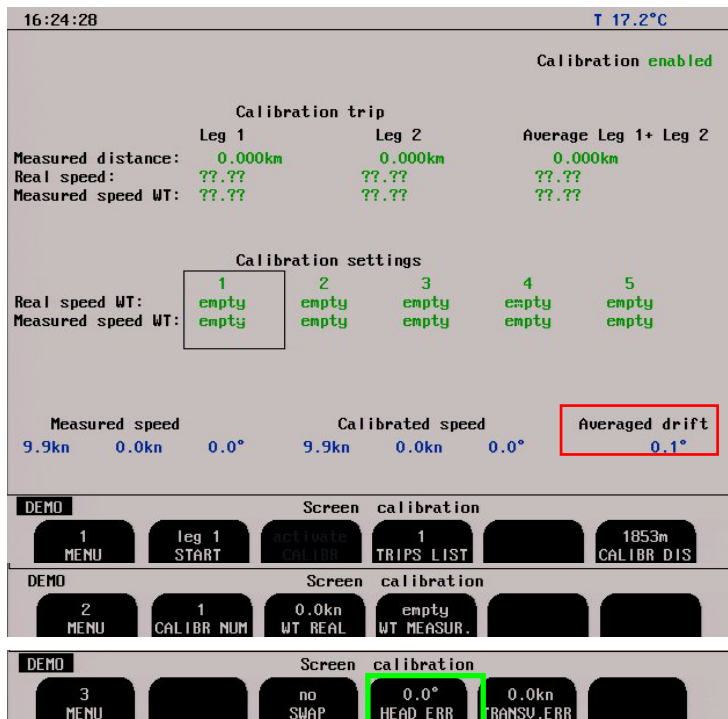

### Step 2a. Manual speed calibration/adjustment:

The user enters speed values directly into the calibration table by comparing to other equipment, such as GPS. This can also be used to adjust values. Menu 2 allows you to enter the values directly. Press and hold an empty button will take the current values and place them in the table.

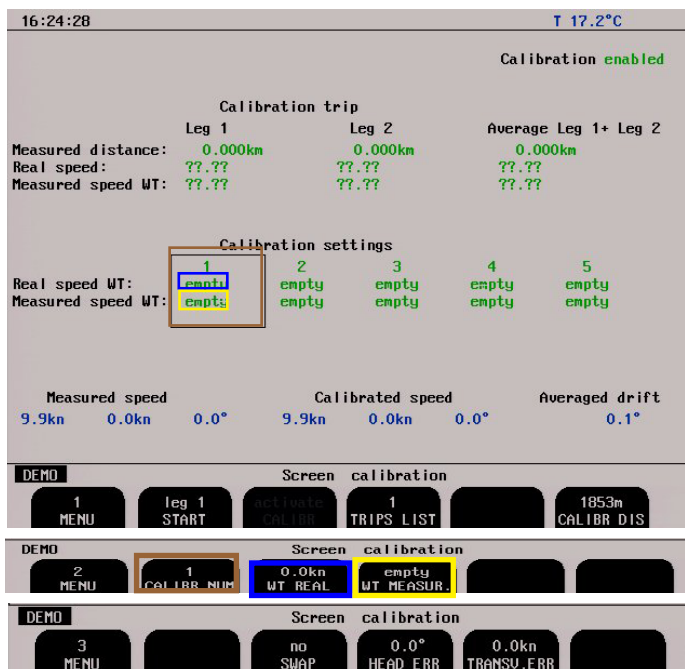

### Screen calibration showing manual adjustment.

Placing values in the WT (Water Track) is not accurate, as it does not take water currents into account. (Step 2b is recommended).

### Step 2b. Semi Automatic calibration:

The vessel is made to sail a known distance and course in both directions, this to remove any water current factors from the speeds.

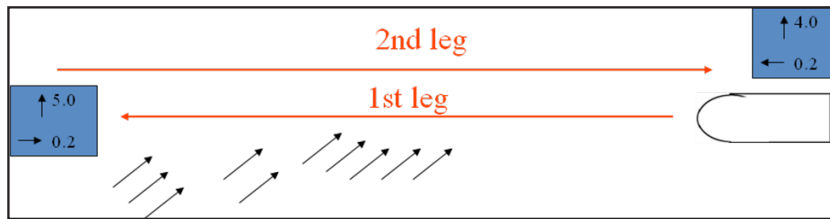

The 1st leg will show a different speed to the 2nd leg, however the direction changes in the second leg so that the average is correct.

The speed can be calibrated as follows:

1. Assuming you have performed step 1 “Heading Error”, plot a known distance on the chart. Enter this value into the **1.000NM CALIBR DIS** on menu 1.

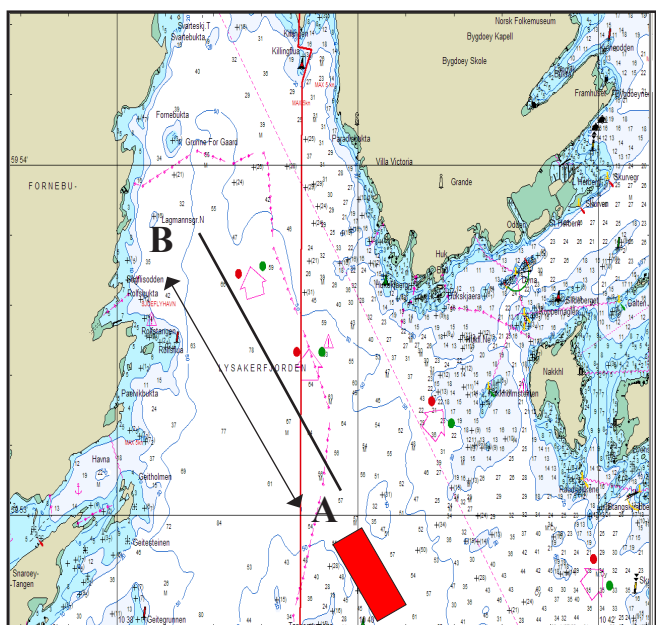

**Figure shows plotting a calibration path on the chart.**

The leg should take at least 5 minutes to sail (distance can be shorter when sailing slowly).

### Calibration

A measured speed 30-50 % lower than real speed is normal on EML. This is due to measurement close to the hull and the hull is “dragging” water. You may have only 1 calibration setting. If this calibration setting is correct and is making a calibration curve valid for all speeds, you do not need any more calibration settings.

Normally we advice to have 2 calibration settings.

- One in low speed
- One in high speed

When this calibration is done, you may check if speed is correct in all speeds. If you have a speed area where speed is different from actual speed, you may make an additional calibration setting in this area.

### Please note!

Only one calibration setting in each speed area. If one calibration setting is wrong, you should correct it and not make an additional calibration setting in the same speed area.



- Sail at a straight course in direction A to B and at a constant speed. When passing to point A, Press **START leg 1** on menu 1. The button text will change to stop and a calibrating warning will show on the screen.

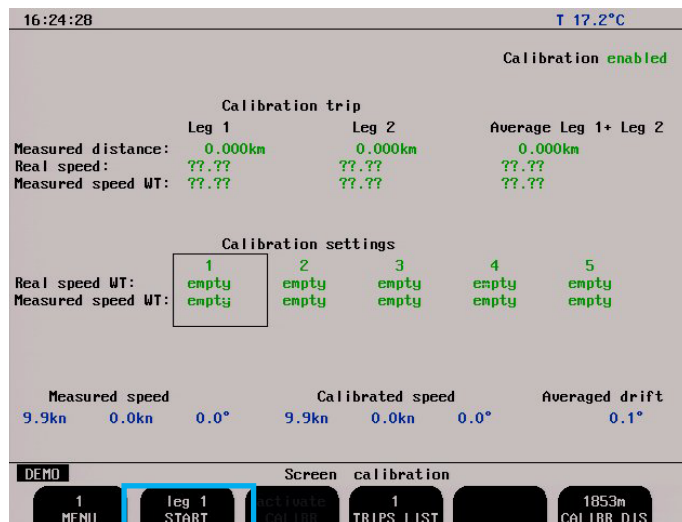
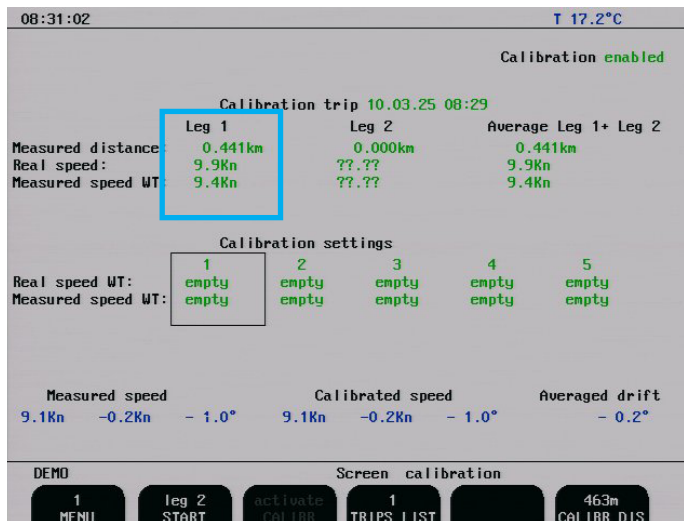

- The **leg 1** measured distance will count up. You may ignore this. When you reach point B, press STOP. The system will then calculate the measured speed (from the measured distance and time) and the real speed (from the Calibr distance and time).
- Turn the vessel and repeat for leg 2 in the opposite

direction at the same speed. The results will show in the **Leg 2 table**. The average of the two legs will show in the final table. This is the correct calibration.

- If the calibration looks correct, you may select which calibration settings table to place it in, and transfer using the **activate calibr** button (which will be active if the calibration is within limits).

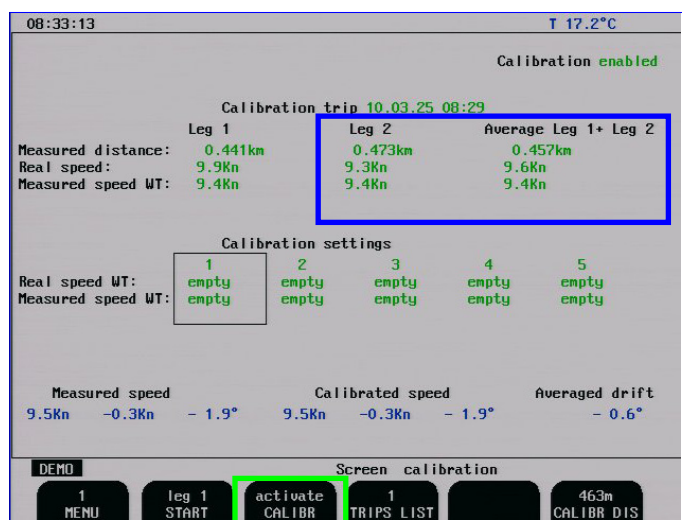
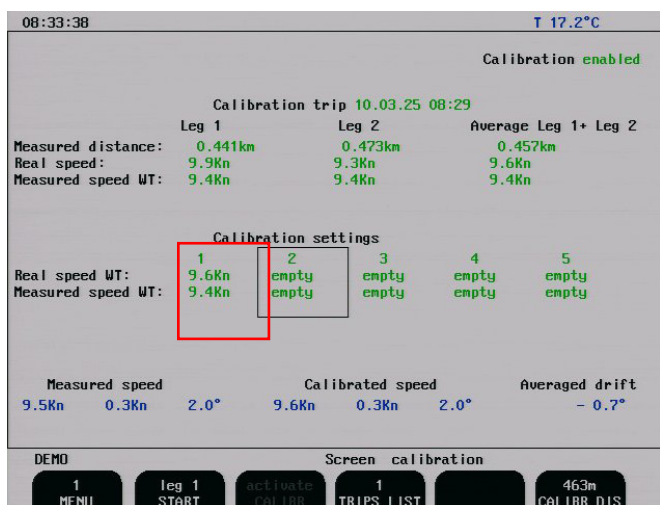

- You have now made a **calibration point**. We recommend a point at low speed (1-3 kn) and one at max speed (20 kn).
- Once calibrated, check the system at other speeds. If it is inaccurate, you may add more points (max 5).

**NOTE:** These values may be overwritten in some software upgrades or if master reset is performed. We advise recording the values somewhere, just in case. EML systems typically have a calibration factor of up to 50 % i.e. measured 5 kn, real 10 kn, depending on mounting position and hull design.

## 7. Specifications

---

### Dimensions

<b>Sensor</b>	Cable length	40 m.
	Mounting	Sea valve or tank.
<b>Electronic Unit</b>	H x W x L	120 x 300 x 300 mm.
	Weight	ca. 6 kg.
<b>Operator unit cabinet</b>	Height, front	340 mm.
	Width	320 mm.
	Depth	170 mm.
	Weight	ca. 10 kg.
<b>Operator Unit Cabinet</b>		
Cut-out for flush mounting	H x W	322 x 302 mm.
Corner radius	4 mm	

### Functional Properties

<b>Display</b>	10.4" 158 x 211 mm TFT LCD, 640 x 480 pixels.
<b>Speed alarms</b>	High and low limits.
<b>Calendar/clock</b>	Year-Month-Day / Hours-Minutes (24 hour system).
<b>Interface outputs</b>	Pulses for speed. Analogue 4 - 20 mA and 0 - 10 V for speed.
	NMEA 0183.
	Alarm relay.
	VGA output for external monitor.
<b>Interface inputs</b>	NMEA 0183 for position, heading and time.
<b>Languages</b>	English, French, Spanish, Russian, German and Norwegian.
<b>Options</b>	Digital speed and distance repeater.

### Performance

<b>Trip counter</b>	Measurement from 0 to 99 999.99 nautical miles.
<b>Distance accuracy</b>	0.2 nm or 2 % whichever is greater.
<b>Speed accuracy</b>	0.2 Kn or 2 % whichever is greater.
<b>Speed range</b>	+/- 40 Kn.
<b>Rolling</b>	More than +/- 10 degrees.
<b>Pitching</b>	More than +/- 5 degrees.
<b>Digital resolution</b>	0.1 knots.

The performance will depend on turbulence, aeration and sea conditions. These effects may lead to occasional incorrect indication of speed and distance. Speed measurement is done directly on the sensor surface, comply with IMO Res. A.824/A1.1



## Environmental according to IEC60945

<b>Operator/Display Unit</b>	AC Supply voltage	230 V (195 - 253 V AC) or 115 V (96 - 125 V AC).
	DC supply voltage	24 V DC (20-32 V).
	Power consumption	50 W at 24 V, 70 W at 230 V or 115 V.
	Alarm relay	Change-over contact, max. 24 V 300 mA.
	NMEA port	9 pin D-type. 2 inputs, 2 outputs.
	Operating temperature	-15 - 55 degree C. To increase serviceability and lifetime, we suggest the working temperature to be held at 0 - 40 degrees C.
	Storage temperature	-20 - 70 degree C.
	Humidity	10 - 90 % relative, no condensation.
	Protection	IP 23.
<b>Electronic Unit</b>	AC Supply voltage	230 V (195 - 253 V AC) or 115 V (96 - 125 V AC).
	DC supply voltage	24V DC (20-32 V).
	Operating temperature	-15 - 55 degree C. To increase serviceability and lifetime, we suggest the working temperature to be held at 0 - 40 degrees C.
	Storage temperature	-20 - 70 degree C.
	Protection	IP33.
<b>Transducer (sensor)</b>	Operating temperature	-15 - 55 degree C.
	Storage temperature	-20 - 70 degree C.
	Protection	Submerged, 6 bar.

## 8. Trouble Shooting

Symptom	Cause	Remedy
<b>Basic System Integrity</b>		
<ul style="list-style-type: none"> <li>No picture on LCD screen.</li> </ul>	<ol style="list-style-type: none"> <li>No AC or DC power to the system.</li> <li>System is in standby mode.</li> <li>Defective LCD module.</li> <li>Voltage(s) out of range.</li> </ol>	<ol style="list-style-type: none"> <li>Check switches and fuses on the terminal board inside the EML224 cabinet.</li> <li>Press any button on the panel.</li> <li>Replace LCD module.</li> <li>Replace terminal PCB.</li> </ol>
<ul style="list-style-type: none"> <li>Picture is difficult to read.</li> </ul>	<ol style="list-style-type: none"> <li>Backlight is too weak.</li> </ol>	<ol style="list-style-type: none"> <li>Increase backlight settings.</li> </ol>
<ul style="list-style-type: none"> <li>Display backlight malfunctions.</li> <li>Display picture is hardly visible.</li> </ul>	<ol style="list-style-type: none"> <li>Error during initialization.</li> <li>Defective backlight tubes.</li> <li>Defective backlight power inverter.</li> </ol>	<ol style="list-style-type: none"> <li>Turn off power and wait for 5 sec. before restart.</li> <li>Replace backlight tubes.</li> <li>Replace inverter PCB.</li> </ol>
<ul style="list-style-type: none"> <li>Rotary encoder malfunctions.</li> </ul>	<ol style="list-style-type: none"> <li>Defective Encoder or interface.</li> <li>SW problem.</li> </ol>	<ol style="list-style-type: none"> <li>Replace keyboard PCB.</li> <li>Recycle power.</li> </ol>
<ul style="list-style-type: none"> <li>Panel buttons malfunctions.</li> </ul>	<ol style="list-style-type: none"> <li>Defective buttons or interface.</li> <li>One button stuck.</li> <li>SW problem.</li> </ol>	<ol style="list-style-type: none"> <li>Replace keyboard PCB or I/O PCB.</li> <li>Check key switches or replace keyboard PCB.</li> <li>Recycle power.</li> </ol>
<ul style="list-style-type: none"> <li>Loose user setup and calibration data.</li> </ul>	<ol style="list-style-type: none"> <li>Battery backup not enabled.</li> <li>Battery empty.</li> </ol>	<ol style="list-style-type: none"> <li>See "<a href="#">Fig. 4.4. Back-up Battery Jumper, I/O Board.</a>" on page 34.</li> <li>Replace battery or I/O board.</li> </ol>
<ul style="list-style-type: none"> <li>Ambient t in status screen shows too high.</li> </ul>	<ol style="list-style-type: none"> <li>Obstructed air flow.</li> <li>Defective fan.</li> </ol>	<ol style="list-style-type: none"> <li>Check installations for obstructions of vent holes.</li> <li>Replace fan.</li> </ol>
<ul style="list-style-type: none"> <li>Wrong main voltages, (Acceptable range)</li> <li>+5V CPU: (4.7 V - 5.3 V)</li> <li>+5V IO: (4.7 V - 5.3 V)</li> <li>+12V CPU: (11.3 V - 12.7 V)</li> <li>+12V IO: (11.3 V - 12.7 V)</li> </ul>	<ol style="list-style-type: none"> <li>Defective power supply.</li> <li>CPU or I/O PCB problem.</li> <li>Terminal PCB problem.</li> <li>CPU problem.</li> </ol>	<ol style="list-style-type: none"> <li>Replace terminal PCB.</li> <li>Replace CPU or I/O PCB.</li> <li>Replace terminal PCB.</li> <li>Replace CPU.</li> </ol>

Symptom	Cause	Remedy
<b>Installation problems</b>		
<ul style="list-style-type: none"> <li>Screen COM RX status shows: <b>No signal.</b></li> <li>In Electronic Unit: <b>LD100 is not active.</b></li> </ul>	<ol style="list-style-type: none"> <li>Electronic Unit power is off.</li> <li>Incorrect supply voltage.</li> </ol>	<ol style="list-style-type: none"> <li>Switch on the power of the transceiver unit or check fuses.</li> <li>Check supply voltage.</li> </ol>
<ul style="list-style-type: none"> <li>Screen COM RX status shows: <b>No signal.</b></li> <li>In Electronic Unit: <b>LD100 is active, LD200 is not active</b></li> </ul>	<ol style="list-style-type: none"> <li>No power to sensor.</li> <li>Bad connection of the sensor cable.</li> <li>Defective sensor or cable.</li> </ol>	<ol style="list-style-type: none"> <li>Check voltage terminal 1 and 2 on J200. Should be 24V.</li> <li>Check if the sensor is connected on the Electronic Unit terminal according to wiring diagram. See <a href="#">“Fig. 4.2. Sensor /Electronic Unit, Wiring diagram.” on page 31.</a></li> <li>Test/replace sensor.</li> </ol>
<ul style="list-style-type: none"> <li>Screen COM RX status shows: <b>No signal.</b></li> <li>In Electronic Unit: <b>LD100 is active, LD200 is active</b></li> </ul>	<ol style="list-style-type: none"> <li>No data from sensor.</li> <li>Com port locking due to “fiddling work” on serial lines.</li> </ol>	<ol style="list-style-type: none"> <li>Sensor must be reconfigured or replaced.</li> <li>Recycle power.</li> </ol>
<ul style="list-style-type: none"> <li>Screen COM RX status shows: <b>Data error.</b></li> </ul>	<ol style="list-style-type: none"> <li>Wrong polarity on serial line from sensor.</li> <li>Wrong polarity on serial line between Electronic Unit and display unit.</li> <li>Damaged communication cable.</li> </ol>	<ol style="list-style-type: none"> <li>Check connection and polarity of the serial lines.</li> <li>Check connection and polarity of the serial lines. See <a href="#">“Fig. 4.2. Sensor /Electronic Unit, Wiring diagram.” on page 31.</a></li> <li>Test/replace cable.</li> </ol>
<b>Interface problems</b>		
<ul style="list-style-type: none"> <li>NMEA input signals are not listed in the NMEA input screen.</li> </ul>	<ol style="list-style-type: none"> <li>Wrong polarity of input signals.</li> </ol>	<ol style="list-style-type: none"> <li>Swap NMEA 0183 input lines.</li> </ol>
<ul style="list-style-type: none"> <li>NMEA input signals are listed in the NMEA input screen, but not accepted by the EML.</li> </ul>	<ol style="list-style-type: none"> <li>Error during initialization.</li> <li>Irregular message mnemonic.</li> </ol>	<ol style="list-style-type: none"> <li>Cycle power of operator unit after NMEA Connection is established.</li> <li>Check remote (talker) setup.</li> </ol>
<ul style="list-style-type: none"> <li>NMEA output signals are not accepted by the remote system.</li> </ul>	<ol style="list-style-type: none"> <li>Remote (listener) setup.</li> </ol>	<ol style="list-style-type: none"> <li>Verify correct remote (listener) setup.</li> </ol>
<ul style="list-style-type: none"> <li>Analogue output malfunctions.</li> </ul>	<ol style="list-style-type: none"> <li>Incorrect range settings.</li> </ol>	<ol style="list-style-type: none"> <li>Verify upper and lower limits in status screen. See <a href="#">“Fig. 2.12. Screen Status, Menu 5” on page 21.</a></li> </ol>
<ul style="list-style-type: none"> <li>Pulse output malfunctions.</li> </ul>	<ol style="list-style-type: none"> <li>Incorrect pulse frequency settings.</li> </ol>	<ol style="list-style-type: none"> <li>Verify pulse settings in status screen. See <a href="#">“Fig. 2.9. Screen Status, Menu 2” on page 18.</a></li> </ol>
<ul style="list-style-type: none"> <li>Alarm output do not work.</li> </ul>	<ol style="list-style-type: none"> <li>Incorrect terminal.</li> <li>Defective output.</li> </ol>	<ol style="list-style-type: none"> <li>Check use of AL NC and AL NO terminals. See <a href="#">“Fig. 11.2. Terminal board connections” on page 58.</a></li> <li>Replace terminal PCB.</li> </ol>
<b>Basic functionality</b>		
<ul style="list-style-type: none"> <li>Constantly wrong speeds or no speed.</li> </ul>	<ol style="list-style-type: none"> <li>Wrong calibration.</li> <li>Growth on sensor.</li> <li>Damaged sensor.</li> </ol>	<ol style="list-style-type: none"> <li>Check calibration/recalibrate.</li> <li>Clean sensor.</li> <li>Replace sensor.</li> </ol>

## Typical Status Screen Contents

The status screen contain information that will facilitate analysis and correction of several problems. Information from the status screen should be sent by fax/E-mail with any report about functional disturbances. This will greatly facilitate remote failure analysis. If it is possible to cycle through the screens and observe this information, several assumptions may be made regarding operation of the EML224 system. Although some of the subsystems necessary for this basic system operation may still suffer from minor or intermittent operation disorders, the fact that it is possible to select and observe this screen, indicate correct operation of the following EML224 subsystems:

- The CPU board is operating.
- The keyboard and backlight PCBs are working.
- The keyboard interface part of the I/O board is working.
- The power supplies on the terminal board are basically working.

The other information on the status screen is a collection of information which may be observed and manipulated with the various screen soft key selections. As a reference, it will often be more convenient to observe the various settings together on this screen than to cycle from screen to screen to check on the soft key texts.

Fig. 8.1 Typical contents of status screen

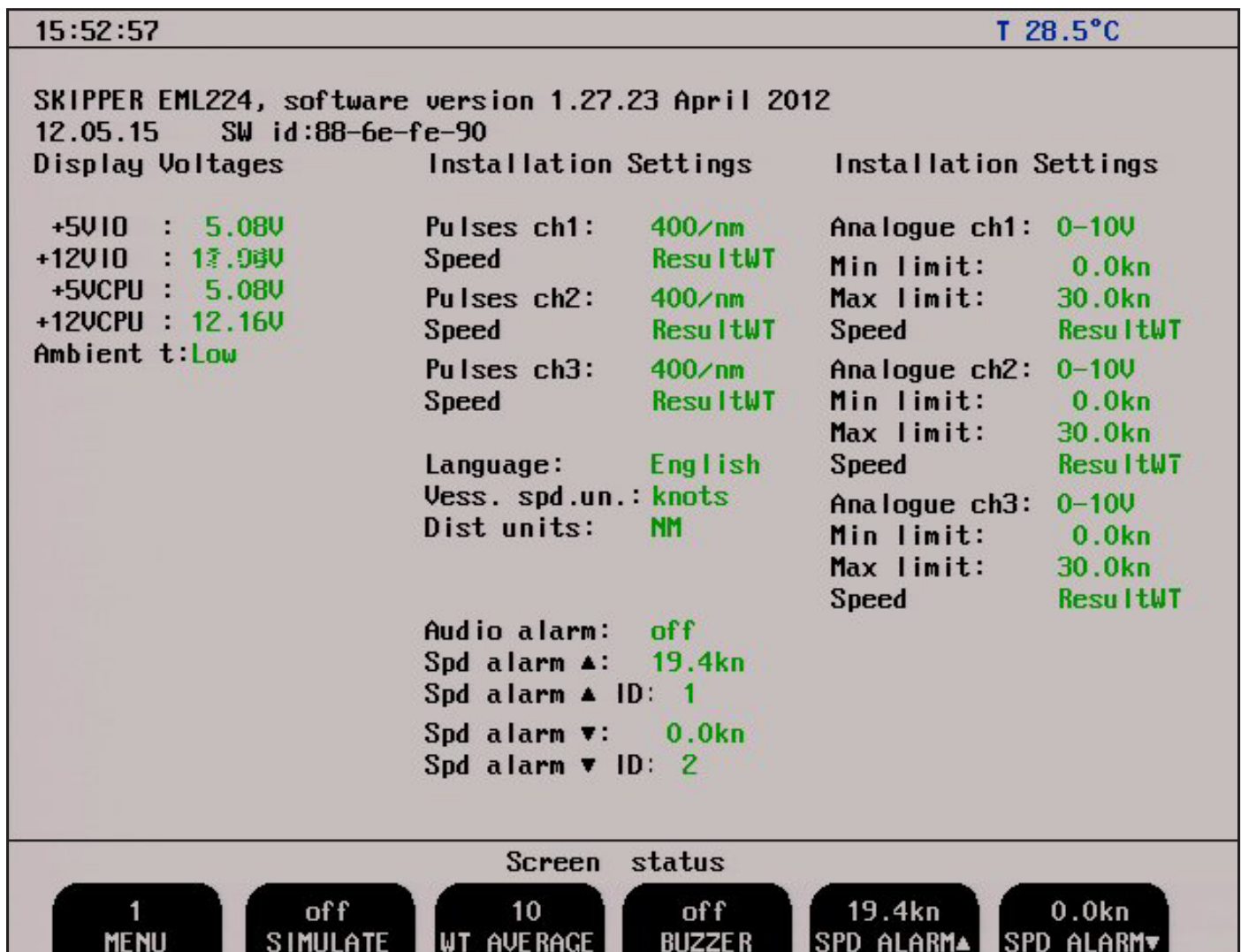

## 9. CPU Board Setup Procedure

---

- Connect a PC keyboard and a VGA screen to the CPU board.
- Switch “On” the unit while pressing “Delete” key on the PC keyboard.
- Do not release the “Delete” key before the “Setup” picture is present on the screen.

### CPU PCA 6742VE

(Bios version 1.12). The PCA 6742 has the default settings with the following changes. Start by loading the optimized defaults, and then change the following:

#### STANDARD CMOS FEATURES

Date: Change to today's date

Time: Change to time now

Halt on: No errors

#### Advanced BIOS Features

- a. Hard Disk priority [Press enter] – Press enter
  - i. 1 should be ch.1 M.
  - ii.2 should be ch 0 M.
- b. First Boot Device [Hard Disk]
- c. Second Boot Device [Hard Disk]
- d. Boot other device [Disabled]

#### Advanced Chipset features

- a. SMI712 VGA Settings [Press Enter] – Press enter
  - i. SMI712 VGA Monitor [Simul monitor]
  - ii. Panel resolution Mode [640x480 TFT]
- b. USB Device Setting [Press Enter] – press enter
  - i. USB1.0 emulation [Disabled]

#### Integral Peripherals

- a. Onboard serial Port 3 [enter]
  - i. Change to [2E8/IRQ9]
- b. Onboard serial Port 4 [enter]
  - i. Change to [3E8/IRQ5]
- c. Parallel Port Mode [EPP]
- d. EPP Mode Select [EPP1.9]

#### PnP/PCI Configurations

- a. Resources Controlled By [Manual]
- b. IRQ Resources [Enter]
  - i. IRQ – 7 assigned to [Legacy ISA]
  - ii. IRQ – 10 assigned to [Legacy ISA]
  - iii. IRQ – 11 assigned to [Legacy ISA]
- c. NO DMA

#### PC Health Status

- a. Case Open Warning [Disabled]

#### SAVE SETTINGS AND EXIT

## Master Reset Procedure

After completed setup procedure, you should always do a “MASTER RESET”.

- Switch off the EML224, using the internal toggle switch(es) and wait a few seconds.
- Then press down and keep pressed the soft key to the far left and far right (no. 1 and 6) in the upper row on the EML224 keyboard.
- Turn the EML224 ‘on’ and keep the two soft keys pressed down until the screen shows the normal picture. This may take as long as app. 30 seconds. You should normally hear 4 “beeps” at the end of the procedure.

## Upgrading Software

New software versions are released from time to time. The EML224 with Compact Flash (CF) can be updated by performing the following software upgrade procedure.

1. If you have received a programmed compact flash, skip stage 2.
2. Copy the received/downloaded software file into the root folder of Compact Flash card. The name of the file is not relevant. Also copy the latest version of setup.exe into the root folder .

**Note:** Standard Compact Flash reader is needed to be attached to the PC.

**Note:** It is possible to use the Compact Flash card, which is already installed in the display unit.

3. Switch “off” the mains of the display unit and insert Compact Flash card with the new software on it.
4. Press the “hidden” button inside the cabinet (mounted on the solder side of the keyboard). Keeping the hidden button pressed, switch “on” the mains in the display unit and keep the button pressed while the message “You may release the upgrade button” appears in the lower part of the screen. If a new setup.exe is to be loaded, follow the on screen instructions.
5. Release the hidden button. After few diagnostic text messages, the list of available software versions will appear in the lower part of the screen as in example below.
6. Note: If the bootloader does not find any file with the software on the Compact Flash, the presently installed version will start automatically. In this case, make sure, that the upgrade and setup file has been copied correctly on the Compact Flash and repeat procedure.

1.27.21	1.27.23
Active	External

KEY 1

KEY 2

KEY 3

KEY 4

KEY 5

KEY 6

7. Select a software version, which you would like to install. Normally, it is possible to chose one out of two: the version, which is currently installed in the internal memory (indicated as Active) and the upgrade version (indicated as External). The version name is displayed in the upper line of the text lines, located just above the corresponding soft key. In the example above, soft key #2 should be pressed to select the latest software version.
8. Confirm selection by pressing YES button (or go back to selection, pressing NO).
9. Press any button to start the upgraded software (or it will start automatically in 5 seconds).
10. Note: The file with a previous software version will be copied back to the Compact Flash card, so it would be possible to re-install it in the similar manner, if desired.



## **10. Service**

---

All service requests should be made to the local SKIPPER representative.

Adjustments and repairs should only be performed by qualified service engineers, and unqualified repair attempts will void the warranty.

## 11. Appendix

---

### Miscellaneous Installation Drawings.

- Fig. 11.1 EML224 System overview. See “[Fig. 11.1. EML224 System overview](#)” on page 57.
- Fig. 11.2 Terminal board connection. See “[Fig. 11.2. Terminal board connections](#)” on page 58.
- Fig. 11.3 Outline dimensions display unit. See “[Fig. 11.3 Outline dimensions Display Unit](#)” on page 59.
- Fig. 11.4 Outline dimensions electronic unit. See “[Fig. 11.4 Outline dimensions Electronic Unit](#)” on page 60.
- Fig. 11.5 Cable gland connections. See “[Fig. 11.5 Cable gland connection](#)” on page 61.

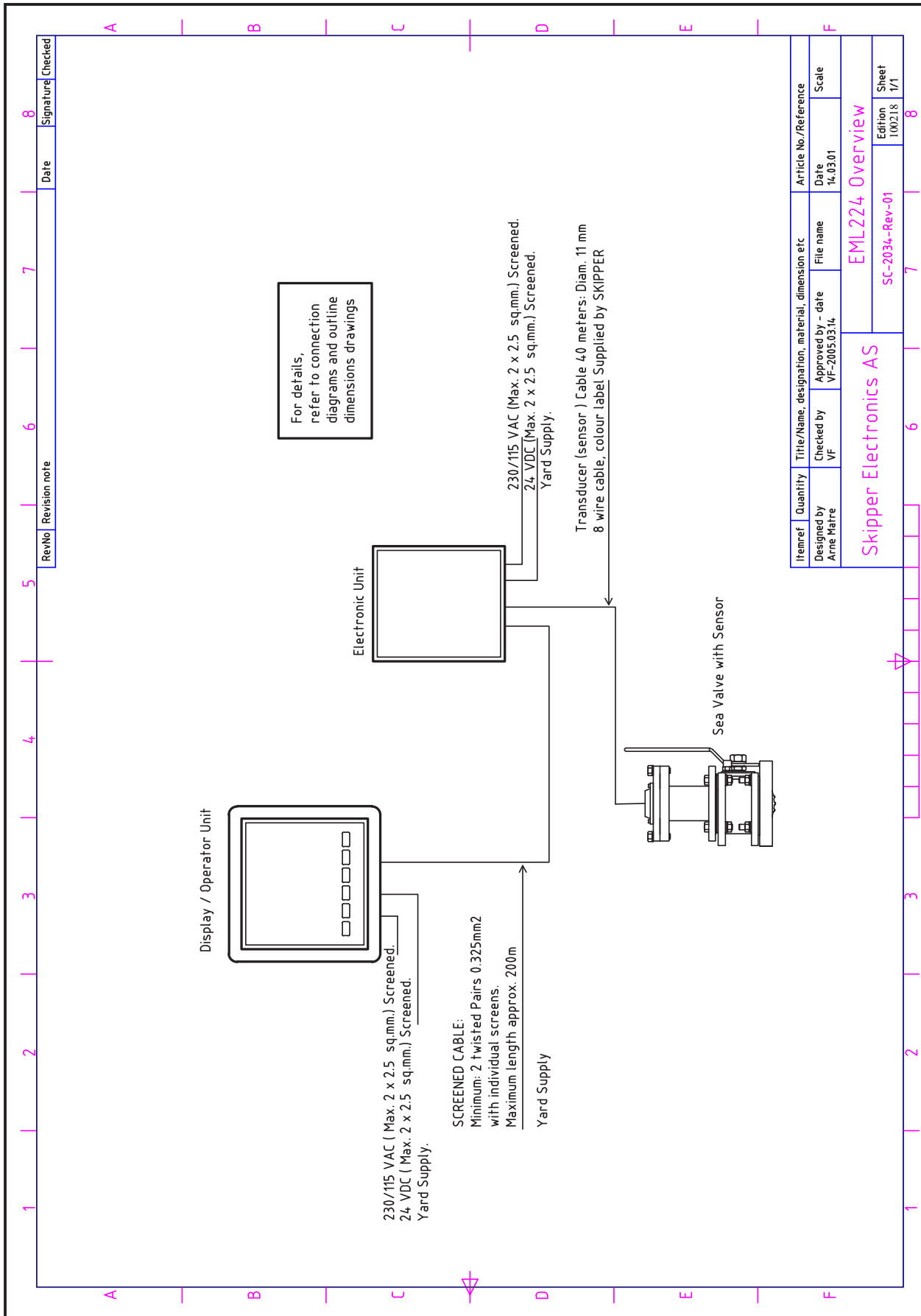

Fig. 11.1. EML224 System overview

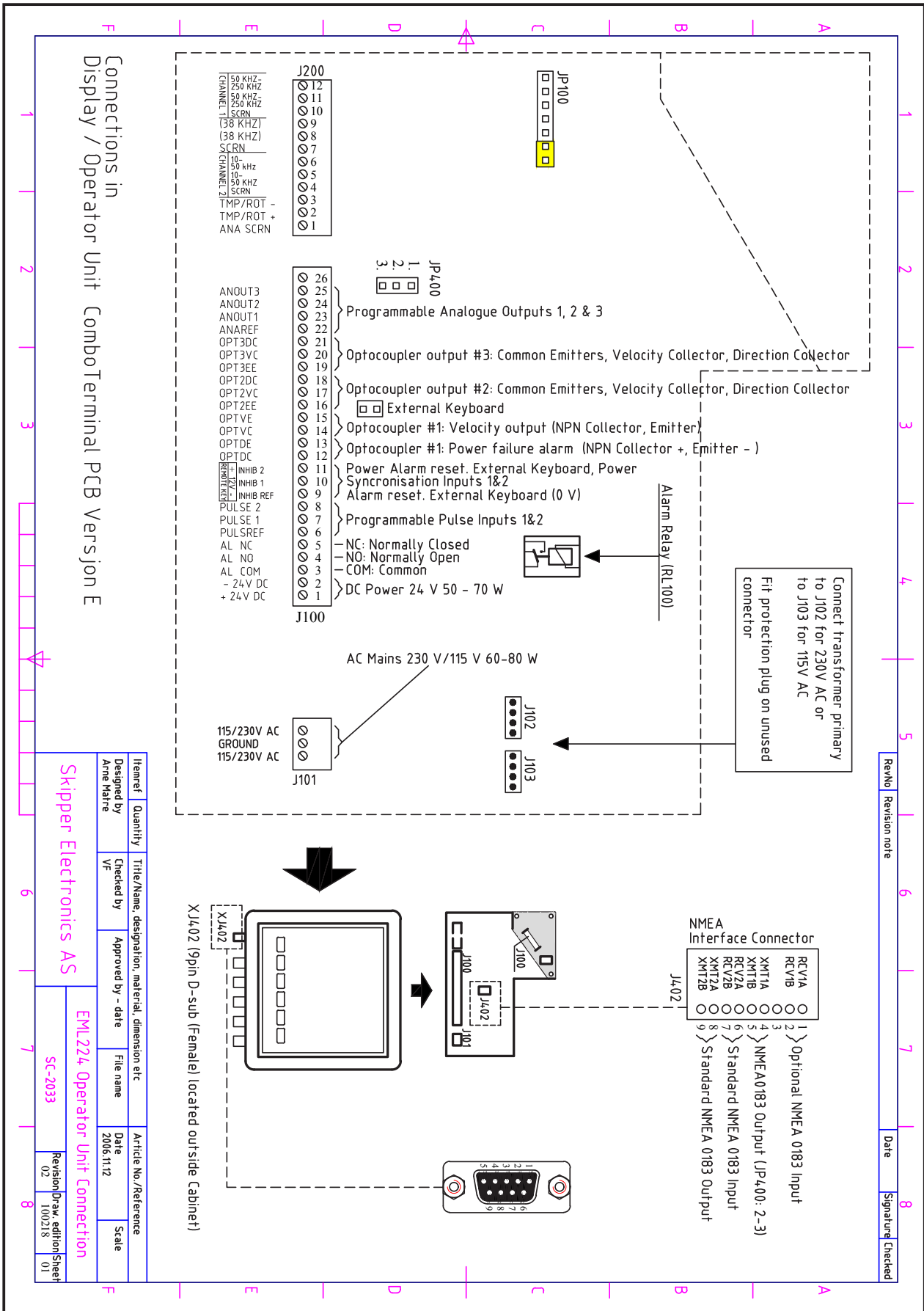
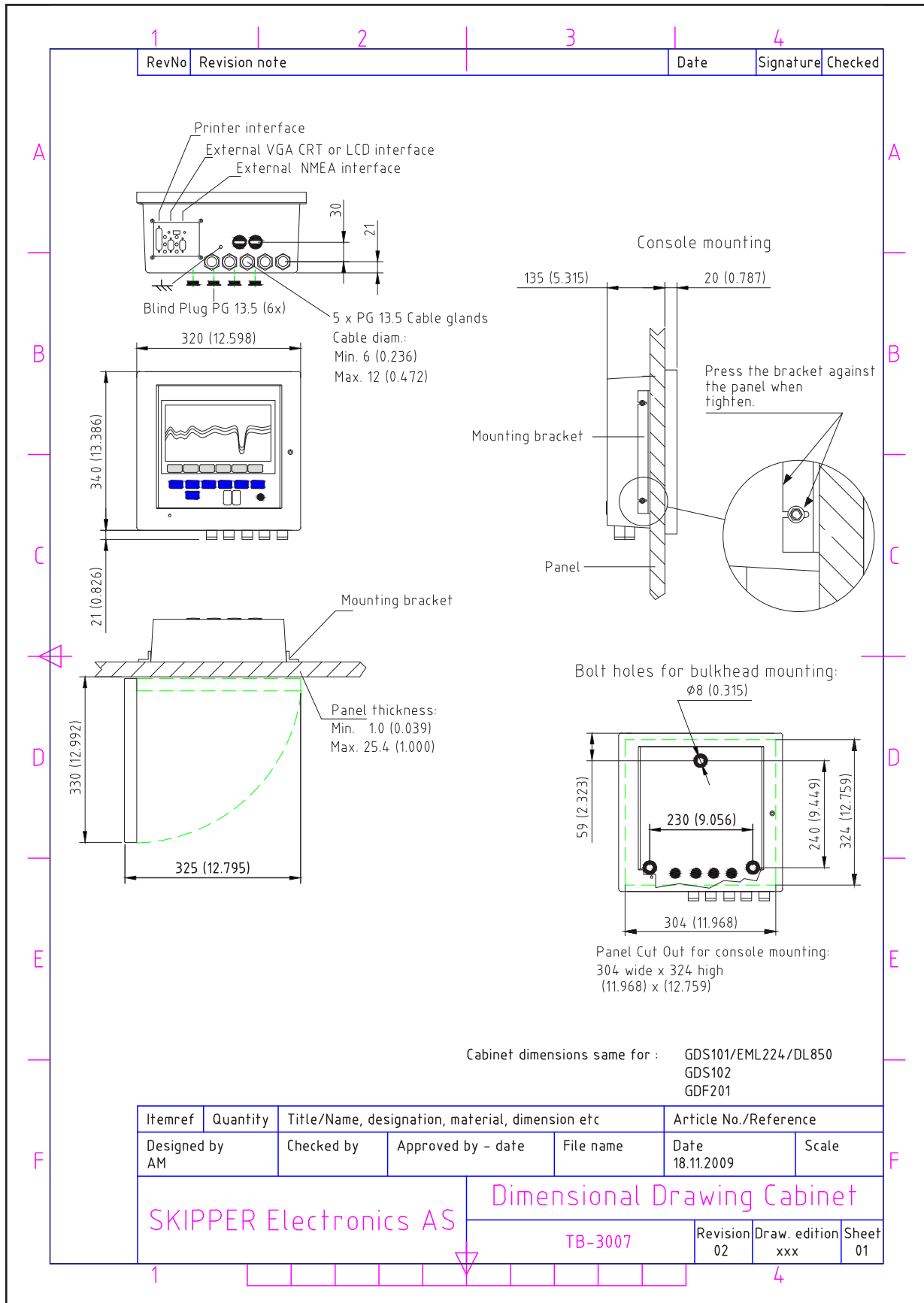
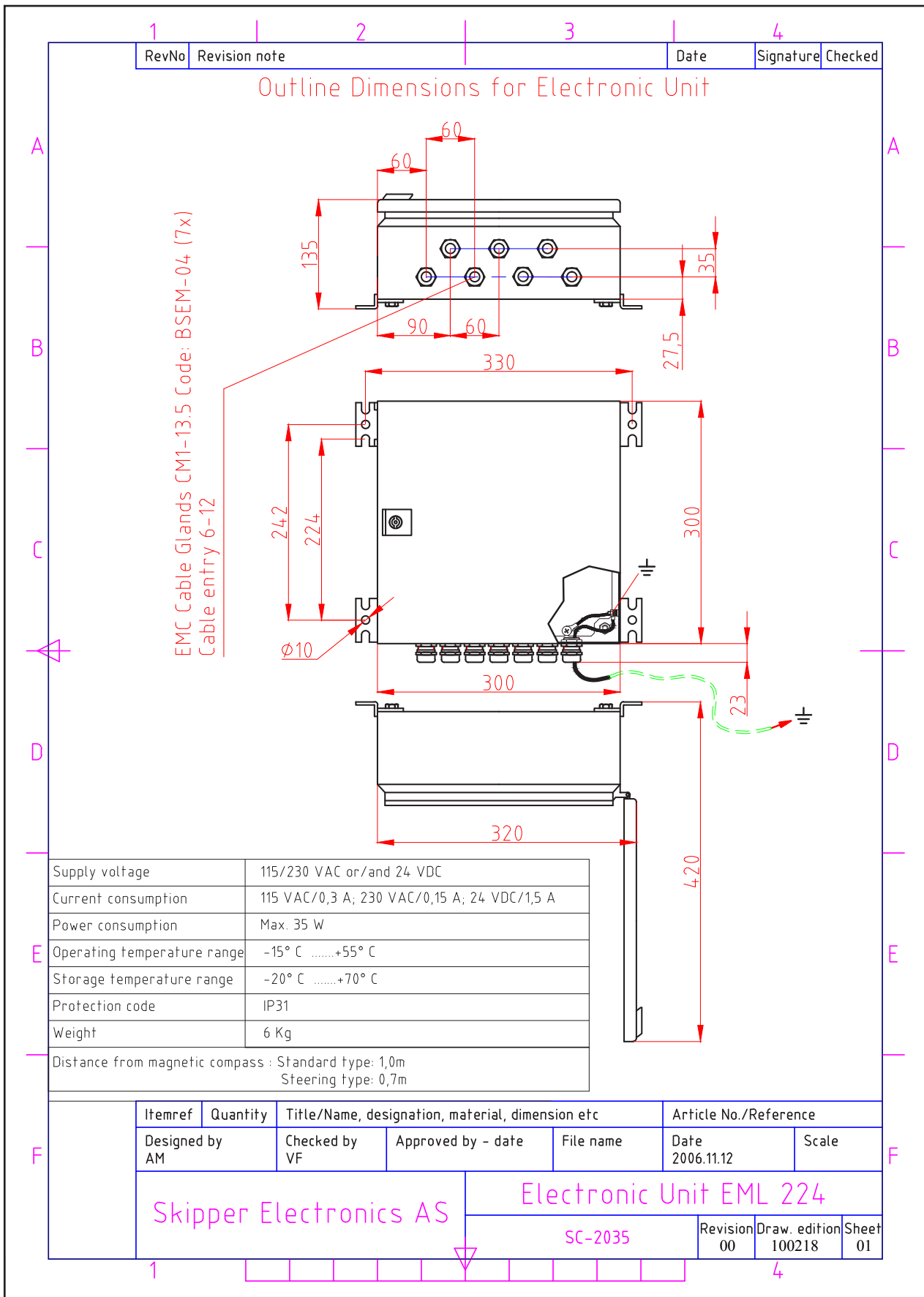

Fig. 11.2. Terminal board connections



**Fig. 11.3 Outline dimensions Display Unit**



**Fig. 11.4 Outline dimensions Electronic Unit**



1		2	3	4
RevNo	Revision note			Date
				Signature
				Checked

**1. Straight braided screen**

**2. Twisted backward .....braided screen**

*The assembly of cable gland is quick and easy:*

1. Partially expose the braided screen by removing the outer sheath of the cable at a length of approx. 10 mm
2. Insert the cable through the dome nut and the gland body until the contact spring is pressed against the braided screen.
3. Firmly screw on dome nut .

*Cable glands play an important part in safeguarding EMC requirements where cables and leads enter into a shielding system. They have to ensure a permanent connection with very low ohmic or inductive resistance between the cable shield and the housing potential.*

Itemref	Quantity	Title/Name, designation, material, dimension etc			Article No./Reference	
Designed by AM	Checked by VF	Approved by - date VF - 2006.12.18	File name	Date	Scale	
SKIPPER Electronics AS			EMC Cable Gland Connection			
			TB-3015	Revision 00	Draw. edition xxx	Sheet 01

**Fig. 11.5 Cable gland connection**

## 12. Notes

---

A series of horizontal dashed lines for taking notes.

## 13. Index

---

### Symbols

115/230 V on Combo Terminal board inside Display Unit 32

### A

Activation of the hidden menus 44  
Alarm acknowledgement 26  
Alarm ID 27  
ALARM ID 15, 16  
Alarm Relay 37  
Alarms 8  
Alarm Settings 27  
ALARM TYPE 15, 16  
Analogue Interfaces 37  
Analogue Outputs and Log Pulse Outputs Range Selection 41  
ANA MAX 21  
ANA MIN 21  
Appendix 56

### B

Backlight adjustment 26  
Back-up Battery Jumper JP200 34  
Basic functionality 51  
Basic System Integrity 50  
BAUD 15, 16  
BUZZER 17

### C

CALIBR 23  
Calibration procedure 43  
Calibration routine: 44  
CALIBR DIS 23  
CALIBR NUM 24  
Clock and Calendar Settings 27  
COM 13, 15, 16  
COM ERROR 13  
CPU Board Setup Procedure 53  
CPU PCA 6742VE 53

### D

DATA 15, 16  
Data Entry 6  
DAY 19  
Day/Night 26  
Dimensions 48  
DISPLAY 13  
DISTANCE 20, 22

### E

EML224 transmitted (originated) NMEA 0183 messages 42  
Environmental according to IEC60945 49  
Example of parameter entry. 9  
External Interface Ports 40

### F

Fig. 1.1 System Overview 7  
Fig. 1.2. Display unit panel layout 8  
Fig. 2.1 Setting and Parameter Entry Flowchart 9  
Fig. 2.2. Schematic overview of screens and soft key menus 10  
Fig. 2.3. Screen A 11  
Fig. 2.4. Screen B 12  
Fig. 2.5 A. Screen Com, Menu 1 13  
Fig. 2.5 B. Screen Com, Menu 1 Error/Warning messages 14  
Fig. 2.6. Screen Com, Menu 2 15  
Fig. 2.7. Screen Com, Menu 2, sensor 16  
Fig. 2.8. Screen Status, Menu 1 17  
Fig. 2.9. Screen Status, Menu 2 18  
Fig. 2.10 Screen Status, Menu 3 19  
Fig. 2.11. Screen Status, Menu 4 20  
Fig. 2.12. Screen Status, Menu 5 21  
Fig. 2.13. Screen Status, Menu 6 22  
Fig. 2.14. Screen Calibration, Menu 1 23  
Fig. 2.15. Screen Calibration, Menu 2 24  
Fig. 2.16. Screen Calibration, Menu 3 25  
Fig. 4.2. Sensor /Electronic Unit, Wiring diagram. 31  
Fig. 4.3. Voltage selection connectors and fuses, Terminal Board, EML224 Operator Unit. 33  
Fig. 4.4. Back-up Battery Jumper, I/O Board. 34  
Fig. 4.5. Function LEDs, Terminal Board. 35  
Fig. 4.6. Input/Output Circuitry. 36  
Fig. 4.7. Alarm interconnection 38  
Fig. 4.8. Misc IO examples 39  
Fig. 4.9 External Interface Ports 40  
Fig. 5.1 9 Pin D-Type NMEA connector XJ402 in cabinet front 42  
Fig. 6.1 Sea valve alignment 43  
Fig. 8.1 Typical contents of status screen 52  
Fig. 11.1. EML224 System overview 57  
Fig. 11.2. Terminal board connections 58  
Fig. 11.3 Outline dimensions Display Unit 59  
Fig. 11.4 Outline dimensions Electronic Unit 60  
Fig. 11.5 Cable gland connection 61  
Fixed Key Functions 26  
Functional Properties 48

### H

HEAD ERR 25  
Heading Error 43  
HOURS 19  
Hull Fitting 29

### I

Index 63  
Inputs 8  
Installation 29  
Installation problems 51  
Interface problems 51  
Interfacing 8, 36, 37  
Introduction 6

### K

Key Functions 26

## L

LANGUAGE 20

Language and Units of Measure 41

Log Pulse Outputs 37

LONG. SP 22

## M

Master Reset Procedure 54

Menu 26

MENU 13, 15, 16, 17, 18, 19, 20, 21, 22, 23, 24, 25

MESSAGE 13

MINUTES 19

Miscellaneous Installation Drawings. 56

## N

NMEA interface 40

NMEA Setup 41

Nonvolatile Parameter Memory 27

Note 15, 16, 18, 19, 20, 23

Notes 62

## O

Operation 9

Operation Screens 10

Operator Unit 6

Operator Unit Installation 32

Operator Unit Maintenance 28

Options 27, 40

OUT MODE 18, 21

OUT NUM 18, 21

OUTPUT 13

Outputs 8

## P

Parameter entry 9

Part Positioning and Welding 29

Performance 48

Power indication and function LEDs 35

Power ON/OFF 26

Principal Functions 26

Principles of Electromagnetic Log 26

PULSES NUM 18

## R

Repeaters 40

Repeaters/speed and distance 27

## S

Screen Select 26

Sensor 6

Sensor/Electronic Unit interconnection 30

Sensor Location 29

Sensor Maintenance 28

Service 55

SIMULATE 17

Simulator 27

SPD ALARM ▲ 17

SPD ALARM ▼ 17

SPD ALARM▲ 11

SPD ALARM▼ 11

SPD TEST 22

Specifications 48

Standard System Supply 29

START 23

Start-up and system adaption 41

Status Screen 27

Step 1. Heading error correction: 45

Step 2a. Manual speed calibration/adjustment: 45

Step 2b. Semi Automatic calibration: 46

SWAP 25

SYSTEM 11, 12

System Summary 6

## T

The Electronic Unit 30

Transducer/Electronic Unit PCB 31

TRANSV. ERR 25

TRANSV. SP 22

TRIP 11

Trip Reset 27

TRIPS LIST 23

Trouble Shooting 50

Typical Status Screen Contents 52

## U

Upgrading Software 54

User Maintenance 28

## V

VESSEL SPD 20

## W

WT AVERAGE 17

WT MEASUR 24

WT REAL 24

## Y

YR.MONTH 19